



Contents

<i>Description</i>	<i>Page</i>
Telpower compact fused disconnect switches	13-2
Telpower miniature fused disconnect switches	13-3
Fused disconnect switches for TPA fuses	
TP11590-4 4-pole disconnect switch	13-4
TP15914 4-pole disconnect switch	13-5
TPA and TPA-B fuses	13-5
Fused disconnect switches for TPS fuses	
15800 1-pole fused disconnect switch	13-6
TPS fuses	13-6
Fused disconnect switches	
TP158HC panel mount, rear access switch	13-7
15100 1-pole switch for use with TPL fuses	13-8
TPHCS Telpower high-current switch	13-9
TPL Telpower 70-600A: 170Vdc fuses	13-10
TPN Telpower 1-600A: 170Vdc fuses	13-11
70 Type Indicating fuses	13-12
15087 fuse holders	13-12
HLS, HLT and PCT fuse holders	13-13
GMT fast-acting fuses	13-13
GMT-A fast-acting fuse	13-13
Telpower specialty fuses	
7 Type fuses	13-14
11 Type fuse	13-14
24 and WER Type non-indicating, visible link fuses	13-14
74 Type fast-acting fuses	13-14
75 Type cylindrical fuses with leads	13-15
76 Type cylindrical fuses with leads	13-15
80 Type visual indicating fuses	13-15

TPC and TPCDS

Specifications

Descriptions:

— **TPC:** Telepower compact current-limiting fuses.

— TPCDS:

Telepower compact fused disconnect switch available in two disconnect switch profiles in addition to a variety of terminal styles. Recommended 0.75" center-to-center product spacing.

Dimensions: See Data Sheet 5023.

Ratings:

Volts: — 80Vdc

Amps: — 3-125A (see catalog numbers table for details)

IR: — 100kA

Agency information: CE, UL Recognized (investigated to UL 1801) as a disconnect switch for the interruption of load current by means of withdrawing the fuse pullout. Recognized to US and Canadian requirements under the component recognition program of Underwriters Laboratories Inc. Files E219046 and E56412.

Flammability ratings: Fuse UL 94V0, 170°C RTI, Housing UL 94V0, 120°C RTI.

Typical applications

- Telecommunications DC power circuit protection
- Replacement of DC telecom circuit breakers
- Applications where venting of arc or molten metals and gases during opening would pose a problem to surrounding devices



Features and benefits

- Highest interrupting rating (100kA) available and complete system coordination for DC circuit protection for compact footprint providing a superior protection solution for replacement of existing DC telecom circuit breakers
- AmpColor ID™ System makes fuse replacement easy
- Local and remote open fuse indication. Local alarm indication provided by LED on TPC fuse
- Remote alarm terminal available in three positions common to DC circuit protection devices

Catalog numbers

TPCS disconnect switch		TPC current-limiting fuse	
Catalog numbers	Amp range	Catalog numbers	Amp rating
TPCDS-BBE-1	3-125	TPC-3	3
TPCDS-BBE-2	3-125	TPC-4	4
TPCDS-BBE-3	3-125	TPC-5	5
TPCDS-BBM-1	3-125	TPC-6	6
TPCDS-BBM-2	3-125	TPC-7	7
TPCDS-BBM-3	3-125	TPC-8	8
TPCDS-BSE-1	3-125	TPC-10	10
TPCDS-BSE-2	3-125	TPC-12	12
TPCDS-BSE-3	3-125	TPC-15	15
TPCDS-BSM-1	3-125	TPC-20	20
TPCDS-BSM-2	3-125	TPC-25	25
TPCDS-BSM-3	3-125	TPC-30	30
TPCDS-SSE-1	3-125	TPC-40	40
TPCDS-SSE-2	3-125	TPC-50	50
TPCDS-SSE-3	3-125	TPC-60	60
TPCDS-SSM-1	3-125	TPC-75	75
TPCDS-SSM-2	3-125	TPC-90	90
TPCDS-SSM-3	3-125	TPC-100	100
TPCDS-D-BC1*	3-125	TPC-125	125
TPCDS-D-BC2*	3-125		
TPCDS-D-CC1*	3-125		
TPCDS-D-SEC1*	3-125		
TPCDS-D-SEC2*	3-125		
TPCDS-D-SMC1*	3-125		
TPCDS-D-SMC2*	3-125		

*Not investigated to Canadian requirements.

TPCDS catalog number system

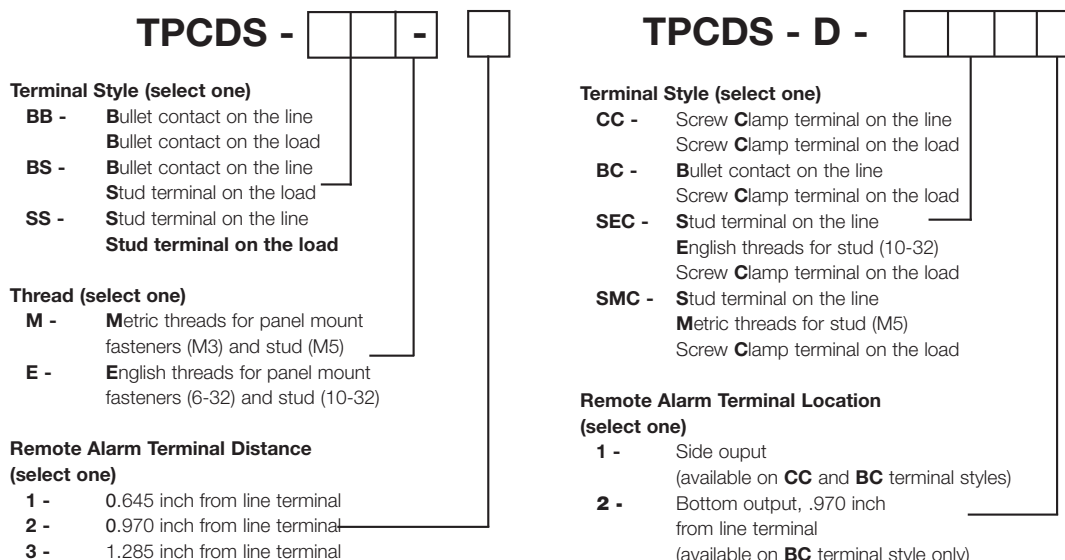

TPM and TPMDS

Specifications

Description:

– **TPM:**

Telepower miniature current-limiting fuses.

– **TPMDS:**

Telepower miniature fused disconnect switch.



Dimensions: See Data Sheet 5022.

Ratings:

- Volts: — 80Vdc
- Amps: — 3-30A
- IR: — 20kA

Agency information: CE, UL Recognized (investigated to UL 1801) as a disconnect switch for the interruption of load current by means of withdrawing the fuse pullout. Recognized to US and Canadian requirements under the component recognition program of Underwriters Laboratories Inc. Files E219046 and E56412.

Flammability ratings: Fuse UL 94V0, 170°C RTI; Switch UL 94V0, 140°C RTI.

Features and benefits

- Smallest and most versatile fused disconnect switch available allowing for assembly into 1 U (1.75"/44.5mm) panel. Easy to connect; Load: ¼" quick-connect or bolted connection with 10-32 (M5) captive nut, Line: ¼" quick-connect or screw connection with clearance hole for #10 (M5) bolt.
- AmpColor ID™ System makes fuse replacement easy
- Switch design provides for easy panel mounting by single captive 4-40 (M3) nut and panel notch integral to switch footprint.
- Complete system coordination capability with local and remote open fuse indication. Local alarm indication provided by LED on TPM fuse (maximum alarm circuit current: 20mA)

Typical applications

- Telecommunications DC power circuit protection
- Applications with restricted space, or mounting in 1 U panels

Catalog numbers

Catalog numbers	Description	Amp rating
TPM-3	Fuse	3
TPM-4	Fuse	4
TPM-5	Fuse	5
TPM-6	Fuse	6
TPM-7	Fuse	7
TPM-8	Fuse	8
TPM-10	Fuse	10
TPM-12	Fuse	12
TPM-15	Fuse	15
TPM-20	Fuse	20
TPM-25	Fuse	25
TPM-30	Fuse	30
TPMDS-E	Disconnect, English hardware	3-30
TPMDS-M	Disconnect, metric hardware	3-30

TPM alarm schematic

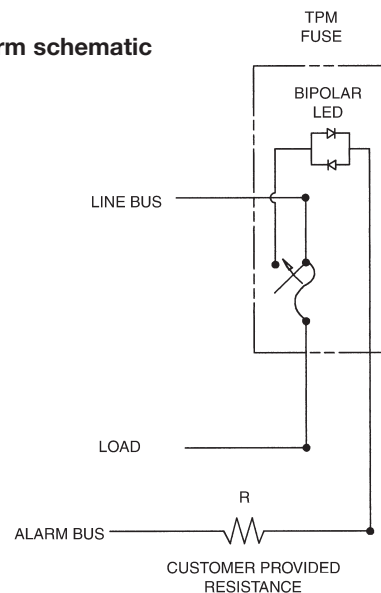

Notes:

1. The resistance, R, must be provided by the end-user to limit the alarm output current to a maximum of 20mA. The value, R, should be calculated using the system voltage value.
 - If remote alarm functionality is not required, the END-USER CIRCUITRY must still be supplied to provide a resistive path to the return for the local alarm to properly function.
2. The fuse is polarized to maintain proper orientation with the switch housing. The line and load terminals are identified on the switch housing.

TP15900-4

Specifications

Description: 4-pole disconnect switch for use with Telepower fuses Type TPA and TPA-B.

Dimensions: See dimensions illustrations.

Ratings:

- Volts: — 145Vdc@40A per pole
- 80Vdc@50A per pole

Agency information: CE, UL Recognized File E97649 as a disconnect switch for interruption of load current by means of withdrawing the fuse carrier. UL Recognized as a component for telecommunication power distribution equipment (UL category QPQY2). UL Recognized fuses for branch circuit protection. CSA Component Acceptance for the system.

Flammability rating: UL 94V0, 140°C.



Features and benefits

- Ease of installation - connection directly to busbar, reduces external wiring per pole. Rear accessibility for line and load terminations
- LED alarm signaling (LED current 30mA max)
- Local and remote open-fuse indication along with fuse orientation rejection feature and fuse presence indication
- Alarm test probe point, to allow on-site checking of alarm circuitry

Typical applications

- Telecommunications DC power circuit protection

Catalog numbers

Catalog

numbers	Description
TP15900-4	4-pole common disconnect switch
TP15900-41	4-pole common disconnect switch w/ split alarm, split line

Available fuses

Product	Ratings (amps)	Volts (Vdc)	IR
TPA	3, 5, 10, 15, 20, 25, 30, 40, 50	170	100kA
TPA-B	20, 25, 30	65	20kA

Accessories

- Spare fuse holders: catalog numbers 5TPH and TPSFH-AS.

Dimensions - mm (in)

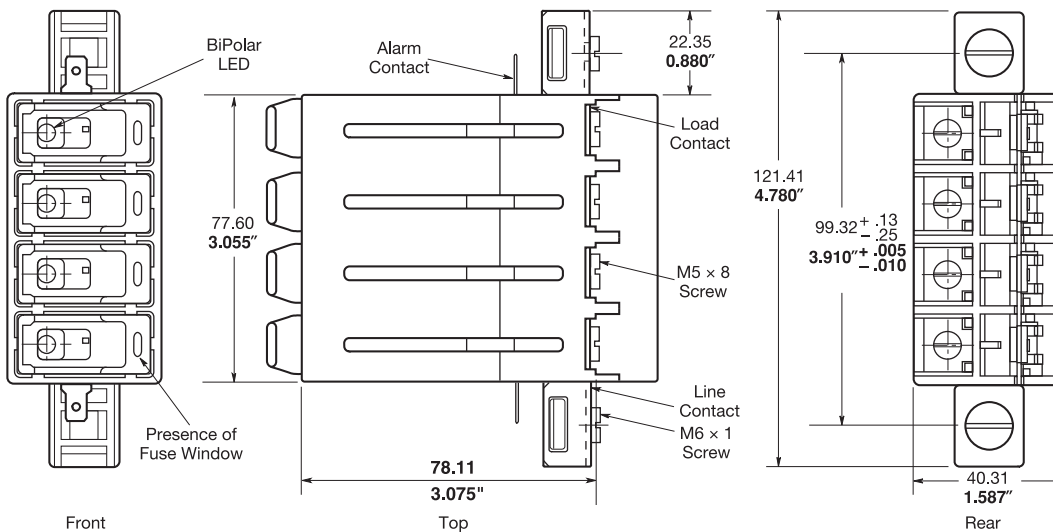

TP15914

Specifications

Description:

Modular 4-pole disconnect switch for TPA fuses — 4-poles per module up to four modules ganged together. Features open fuse indication and fuse presence indication along with fuse orientation rejection feature.

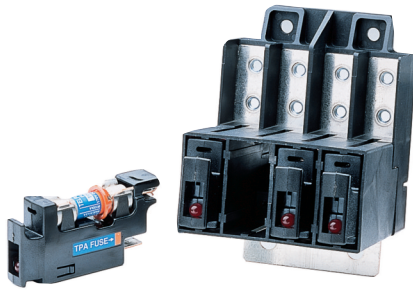

Dimensions: See dimensions illustrations.

Ratings:

Volts: — 145Vdc
Amps: — 50A per pole

Agency information: CE, UL Recognized as a disconnect switch for interruption of load current by means of withdrawing the fuse carrier. UL Recognized as a component for telecommunication power distribution equipment (UL category QPQYZ), UL Recognized fuses for branch circuit protection, CSA component acceptance for the system. UL Recognized, Guide JFHR2, File E56412., CSA Certified, Class 1422-30, File 53787.

Flammability rating: UL 94V0, 150°C.

Features and benefits

- Totally enclosed module directly connects to busbar for reduced external wiring—per pole and easy installation with front access load and line connection standard—double lug load connections 8 AWG wire
- LED alarm signaling (LED current 30mA max)
- Remote alarm with alarm test probe point to allow on-site checking of alarm circuitry

Typical applications

- Telecommunications DC power circuit protection

Catalog numbers

Catalog numbers	Hardware
TP15914	English
TP15914-1	Metric

Dimensions mm - (in)

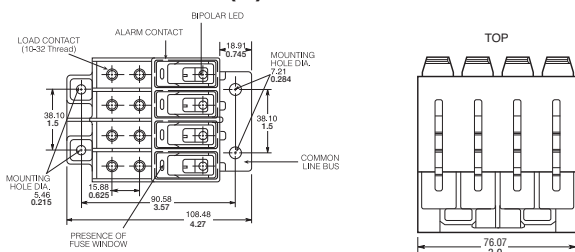

Accessories

- Spare fuse holders: catalog numbers 5TPH and TPSFH-A

Data Sheet: 5011

TPA and TPA-B

Specifications

Description: DC power distribution indicating fuses.

Dimensions: See dimensions illustration.

Ratings:

Volts: — 170Vdc TPA
 — 65Vdc TPA-B
Amps: — 3-50A TPA
 — 20-30A TPA-B
IR: — 100kA TPA
 — 20kA TPA-B



Agency information: CE, UL Recognized, Guide JFHR2, File E56412, CSA Certified, Class 1422-30, File 53787.

Features and benefits

- Indication pin provides for local and remote indication when used with Bussmann series TP15900-4 and TP15914 disconnect switches
- Patented “orange ring” fuse orientation features assures correct fuse position
- The UL Recognized ratings and current-limiting capability make this fuse ideal for cable protection on existing DC power distribution systems
- A unique blue label is used on all Telepower fuses to designate their DC capability

Typical applications

- Telecommunications DC power circuit protection

Catalog numbers (amps)

Catalog numbers	Amp rating	Catalog numbers	Amp rating
TPA-3	3	TPA-30	30
TPA-5	5	TPA-40	40
TPA-10	10	TPA-50	50
TPA-15	15	TPA-B-20	20
TPA-20	20	TPA-B-25	25
TPA-25	25	TPA-B-30	30

Dimensions - mm (in)

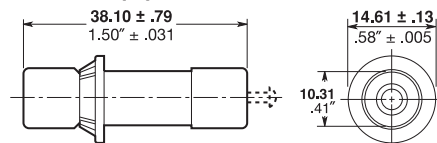

Accessories

- Spare fuse holders: 5 position holder; 5TPH; 6 position holder; TPSFH-AS
- Use with fused disconnect switches TP15900-4, TP15914

Data Sheet: 5012

15800

Specifications

Description: Fused disconnect switch for use only with the following fuses;
Main: Telepower TPS 1 to 70 Amp.

Alarm: Bussmann series GMT-A only (page 13-13).
Recommend GMT-X Cover (page 13-13).

Dimensions: See dimensions illustration.

Ratings:

Volts: — 60Vdc

Amps: — 3-70A

SCCR: — 100kA

Agency information: CE, UL Recognized, Guide QPQY2, File E97649.

Flammability rating: UL 94V0, 150°C.

Features and benefits

- Alarm output with wire wrap terminal or connection to 0.063" thick common alarm bus
- Spare alarm and power fuse compartment
- Mounting hardware included

Typical applications:

- Telecommunications DC power circuit protection

Catalog numbers

Catalog numbers	Access panel mounting
15800-R-200	Rear
15800-F-200	Front

Dimensions - in (mm)

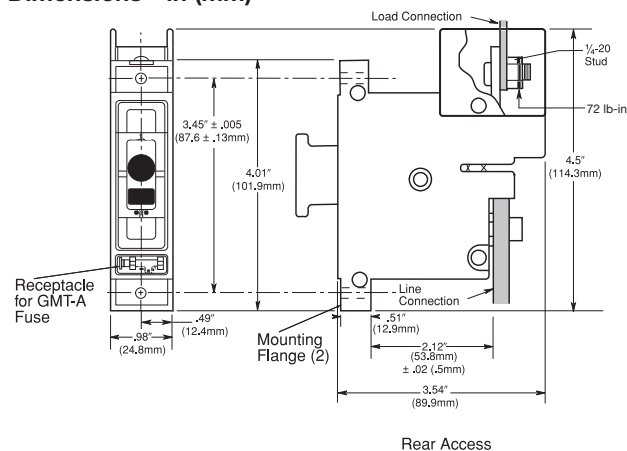

Accessories

- Spare fuse holders: catalog numbers TPSFH-AS (TPS fuses) and TPSFH-T (GMT fuses).

Data Sheet: 5002

TPS

Specifications

Description: DC power distribution non-indicating fuses specifically designed to meet the unique needs of DC power distribution systems. For use with Bussmann series fused disconnect switch 15800.

Dimensions: See dimensions illustration.

Ratings:

Volts: — 170Vdc

Amps: — 1-70A

IR: — 100kA

Agency information: CE, UL Recognized, Guide JFHR2, File E56412, RoHS compliant.

Features and benefits

- The UL Recognized ratings and current-limiting capability make this fuse ideal for cable protection on existing DC power distribution systems
- A unique blue label is used on all Telepower fuses to designate their DC capability
- Printed circuit board variations available

Typical applications

- Telecommunications DC power circuit protection
- Applications requiring printed circuit board mounting

Catalog numbers (amps)

TPS-1	TPS-6L	TPS-30	TPS-50V
TPS-1L	TPS-10	TPS-30L	TPS-60
TPS-2	TPS-10L	TPS-35	TPS-60L
TPS-2L	TPS-15	TPS-35L	TPS-70
TPS-3	TPS-15L	TPS-40	TPS-70L
TPS-3L	TPS-20	TPS-40L	TPS-70LB
TPS-5	TPS-20L	TPS-40V	
TPS-5L	TPS-25	TPS-50	
TPS-6	TPS-25L	TPS-50L	

Suffix: L = PCB tab V = Vertical PCB tab LB = Bolt tag

Dimensions - in (mm)

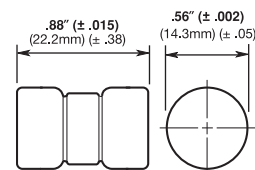

Accessories

- Spare fuse holder: TPSFH-AS, see page 15-6.

Data Sheet: 5009



TP158HC

Specifications

Description: Panel mount, rear access high amp version of Bussmann series 15800 fused disconnect switch for use only with the following fuses; Main: Telepower TPL-B 70-250 Amps, Alarm: Bussmann series GMT-A.

Dimensions: See Data Sheet 5021.

Ratings:

Volts: — 80Vdc
 Amps: — 70-250A
 SCCR: — 100kA

Agency information: UL Recognized (investigated to UL 1801) as a disconnect switch for the interruption of load current by means of withdrawing the fuse pullout. Guide QPQY2, File E97649.

Flammability rating: UL 94V0, 150°C.

Features and benefits

- Similar profile, mounting method, and backplane configuration as 15800. The TP158HC can be installed into existing 15800 panels using the space of two 15800 disconnects
- Innovative new fuse pullout design eliminates need for tools to replace the Telepower type TPL-B fuse
- Alarm output with wire wrap terminal or connection to 0.063 inch (1.6mm) thick common alarm bus
- Hardware included: Load: washer, split lockwasher, and 5/16 - 18 nut (metric-M8 x 1.25)

Typical applications:

- Telecommunications DC power circuit protection

Catalog numbers

Catalog numbers	Hardware
TP158HC	English
TP158HC-M	Metric

Accessories

- Spare fuse holders: TPSFH-LB (TPL-B fuses) and TPSFH-T (GMT fuses).



Application notes

- The line connection uses a 1/4-20 bolt (metric – M6X1) that threads into the line terminal. The line terminal is designed with a float of ±0.02" (±0.50mm) to allow for variation in the distance between the TP158HC mounting flange and the line busbar (see Dimensions). Equipment should be designed to eliminate any relative movement between the TP158HC mounting flange and the line busbar.
- The alarm circuit is not intended for precharging of capacitive circuits. Alarm circuit current 1A maximum.



Easy fuse replacement



Telecom protection products

15100

Specifications

Description: Fused disconnect system for use with Telepower fuses Type TPL.

Dimensions: See dimensions illustrations.

Ratings:

Volts: — 60Vdc

Amps: — 70-800A

SCCR: — 100kA

Agency information: CE, UL Recognized, Guide QPQY2, File E97649.

Features and benefits

- Single-pole fusible disconnect switch for primary DC power distribution
- Robust housing and terminal construction for demanding applications
- Panel mounting
- Easily connected to line or load bus

Typical applications

- Telecommunications DC power circuit protection

Catalog numbers

Catalog numbers	For use with TPL fuses
15100-401	70-400A
15100-601	300-800A



Dimensions - in (mm)

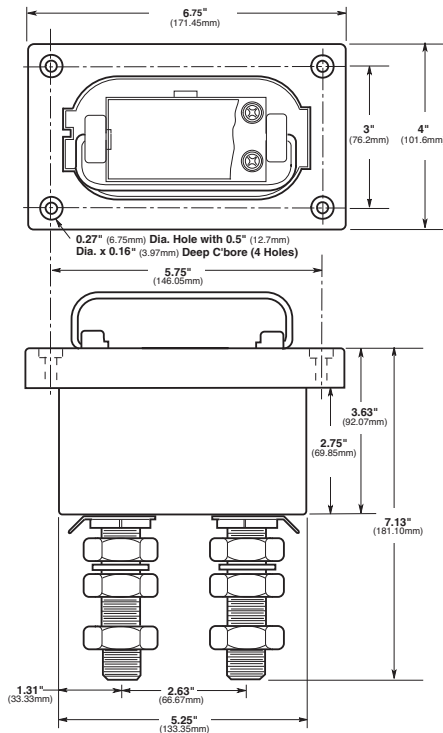

Data Sheet: 5003

TPHCS

Specifications

Description: High current switch for use with Telepower fuses Type TPL-B, TPL-C and TPH.

Available as complete switch or pullout. Base may be purchased separately.

Dimensions: See dimensions illustrations.

Construction:

Ratings:

Volts: — 80Vdc

Amps: — 70-800A

SCCR: — 100kA

Agency information: UL Recognized (investigated to UL 1801) as a disconnect switch for the interruption of load current by means of withdrawing the fuse carrier. UL Recognized to meet the requirements for Canadian Standards.

Features and benefits

- Innovative design eliminates need for tools to replace the Telepower™ Type TPL-B, TPL-C or TPH fuse
- Easy to install—captive fasteners allow for direct busbar mounting (bolts not included). Standard ¼" male quick-connect terminal for effortless remote alarm connection.
- Optional new electronic alarm eliminates need for parallel indicating fuses while providing local and remote open-fuse indications (maximum remote alarm current: 20mA); Bipolar alarm: designed for both central office and Radio applications, Local LED alarm indication for ease-of-viewing.
- Fuse presence window allows for easy viewing of installed fuse amp rating

Typical applications

- Telecommunications DC power circuit protection
- Compact design is ideal for today's high power, high-density cabinets

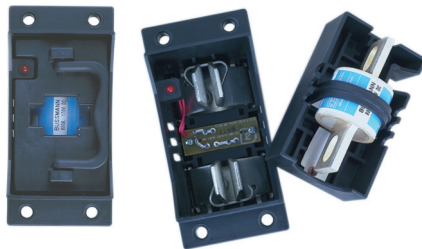

TPHCS800-MAV (shown)

Catalog numbers – switches (pullout and base)

Catalog numbers	Hardware/option	Fuse symbol	Amp rating
TPHCS250-M	Metric	TPL-B	70-250
TPHCS250-E	English	TPL-B	70-250
TPHCS250-ML	Metric, LED	TPL-B	70-250
TPHCS250-EL	English, LED	TPL-B	70-250
TPHCS250-MAV	Metric, Alarm	TPL-B	70-250
TPHCS250-EAV	English, Alarm	TPL-B	70-250
TPHCS800-M	Metric	TPL-C or TPH	300-800
TPHCS800-E	English	TPL-C or TPH	300-800
TPHCS800-ML	Metric, LED	TPL-C or TPH	300-800
TPHCS800-EL	English, LED	TPL-C or TPH	300-800
TPHCS800-MAV	Metric, Alarm	TPL-C or TPH	300-800
TPHCS800-EAV	English, Alarm	TPL-C or TPH	300-800

Catalog numbers – components

Catalog numbers	Description rating/hardware/option	Fuse symbol	Amp rating
TPHCS250-P	Pullout only – 250A	TPL-B	70-250
TPHCS800-P	Pullout only – 800A	TPL-C or TPH	300-800
TPHCS-B-M	Base only, metric	—	800 max
TPHCS-B-E	Base only, English	—	800 max
TPHCS-B-ML	Base only, metric, LED	—	800 max
TPHCS-B-EL	Base only, English, LED	—	800 max
TPHCS-B-MAV	Base only, metric, alarm	—	800 max
TPHCS-B-EAV	Base only, English, alarm	—	800 max

Dimensions - mm (in)

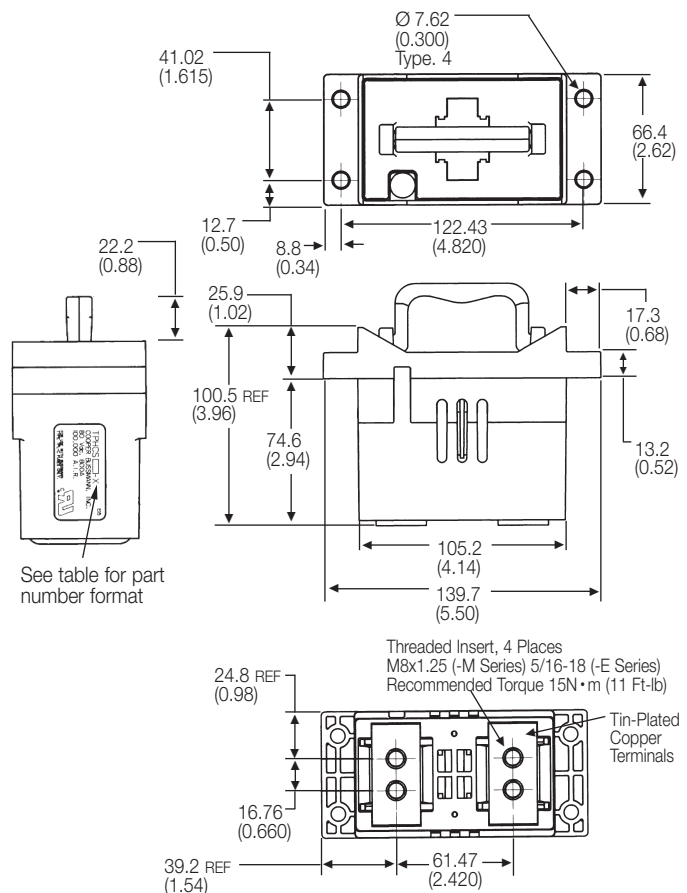

NOTES:

1. TPHCS250 and TPHCS800 pullouts and bases are the same with exception to the type of fuse, TPL-B, TPL-C or TPH the pullout will carry.
2. Plastic rated UL 94V0, 140°C RTI.

TPL

Specifications

Description: DC power distribution fuses for use with Telepower 15100, 15200, TP158HC and TPHCS disconnect systems. For replacement of Bussmann series UBO fuses a TPL-TA adapter kit is necessary.

Dimensions: See dimensions illustrations.

Ratings:

Volts: — 170Vdc
 Amps: — 70-800A
 IR: — 100kA

Agency information: CE, UL Recognized Guide JFHR2, File E56412 Bellcore.

Features and benefits

- Current-limiting capability designed for DC power distribution systems
- Recognized branch circuit protection
- Complete system coordination capability
- Energy savings with low watts loss, low operating temperatures, and minimum I²t levels

Typical applications

- Telecommunications power circuit protection

Catalog numbers

Catalog numbers	Amp rating
TPL-BA	70
TPL-BB	80
TPL-BC	90
TPL-BD	100
TPL-BE	125
TPL-BF	150
TPL-BG	175
TPL-BH	200
TPL-BK	225
TPL-BL	250
TPL-CN	300
TPL-CO	350
TPL-CR	400
TPL-CU	450
TPL-CV	500
TPL-CZ	600
TPL-CZH	800

Accessories

- Spare fuse holders: TPSFH-LB (for TPL-B fuses)
 TPSFH-LC (for TPL-C fuses)



Dimensions - in (mm)

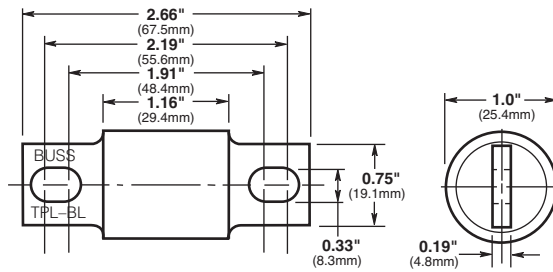

TPL-BA, TPL-BD, TPL-BF, TPL-BH, TPL-BK, and TPL-BL

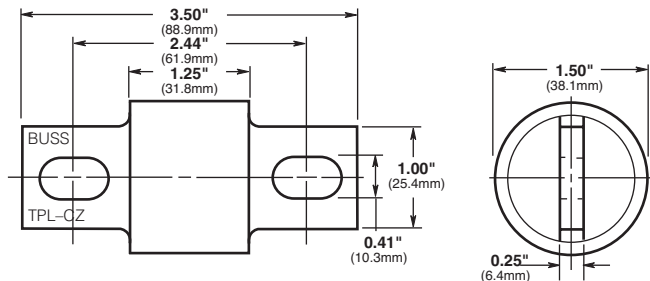

TPL-CN, TPL-CR, TPL-CV and TPL-CZ

TPN

Specifications

Description:

Current-limiting DC power distribution fuses. The TPN fuse is dimensionally similar to Class R fuses making it easy to use standard Class R fuse blocks.



Dimensions: See dimensions illustrations.

Ratings:

- Volts: — 170Vdc
- Amps: — 1-600A
- IR: — 100kA

Agency information: UL Recognized, Guide JFHR2, File E56412.

Features and benefits

- Current-limiting capability designed for DC power distribution systems
- Recognized branch circuit protection
- Complete system coordination capability
- Energy savings with low watts loss, low operating temperatures, and minimum I²t levels

Typical applications

- Telecommunications power circuit protection

Catalog numbers (amps)

TPN-1	TPN-45	TPN-200
TPN-3	TPN-50	TPN-225
TPN-5	TPN-60	TPN-250
TPN-6	TPN-70	TPN-300
TPN-10	TPN-80	TPN-350
TPN-15	TPN-90	TPN-400
TPN-20	TPN-100	TPN-450
TPN-25	TPN-110	TPN-500
TPN-30	TPN-125	TPN-600
TPN-35	TPN-150	
TPN-40	TPN-175	

Dimensions - in (mm)

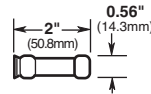

1A to 30A

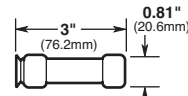

35A to 60A

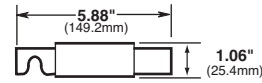

70A to 100A

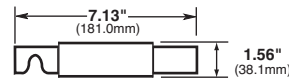

110A to 200A

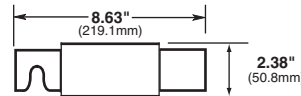

225A to 400A

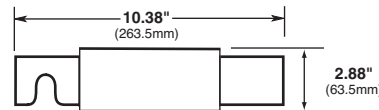

450A to 600A

Accessories

- Spare fuse holders:TPSFH-N30 (for TPN 1-30) TPSFH-N60 (for TPN 35-60)

Recommended Class R fuse blocks

Amps	Poles	Catalog number
1-30	1	RM25030-1CR
1-30	2	RM25030-2CR
1-30	3	RM25030-3CR
35-60	1	RM25060-1CR
35-60	2	RM25060-2CR
35-60	3	RM25060-3CR
70-100	1	RM25100-1CR
70-100	2	RM25100-2CR
70-100	3	RM25100-3CR
110-200	1	RM25200-1CR
110-200	3	RM25200-3CR
225-400	1	RM25400-1CR
225-400	3	RM25400-3CR
450-600	1	RM25600-1CR
450-600	3	RM25600-3CR

70 Type

Specifications

Description: Indicating type fuse.

Ratings:

Volts: — 125Vac/300Vdc

Amps: — 1/10-10A

IR: — 1kA @ 300Vdc

Agency information: CE, UL Recognized, Guide JDYX2, File E19180 Bellcore.

Catalog numbers

Catalog numbers	Amp rating	Color code	Lucent comcode ref. no.	Code/ list no.
70P-1/10A*	1/10	Gray/Wh	100203413	KS23751-L10
70R-15/100A*	15/100	Red/Wh	101384550	KS23751-L11
70E-18/100A*	18/100	Yellow	100203363	KS23751-L5
70X-2/10A	2/10	Black	—	—
70F-1/4A*	1/4	Violet	100203371	KS23751-L6
70K-1/4A*	1/4	Violet/Wh	100203405	KS23751-L9
70G-1/2A*	1/2	Red	100203389	KS23751-L7
70H-3/4A*	3/4	Brown	100203397	KS23751-L8
70I-1A	1	Pink	—	—
70A-1 1/2A*†	1 1/2	White	100203322	KS23751-L1
70B-2A*	2	Orange	100203330	KS23751-L2
70C-3A*	3	Blue	100203348	KS23751-L3
70J-3 1/2A	3 1/2	Black/Wh	—	—
70D-5A*	5	Grn/Blk	100203355	KS23751-L4
70L-6A	6	Grn/Wh	—	—
70M-8A	8	Brown/Wh	—	—
70N-10A	10	Violet/Yel	—	—
GKB-10A	10	Violet/Yel	—	—
72A Plastic Case	Dummy	—	100203421	—
72B Blister Pack	Dummy	—	103757977	—

*Product designed to comply with Bellcore Technical Reference TR-TSY-000799 Issue 1, December 1988.

†Not UL Recognized.



15087 fuse holder

Specifications

Description: Fuse holder for 70 type fuses.

Ratings:

Volts: — 300Vdc

Amps: — 12A

Agency information: CE, UL Recognized, Guide IZLT2, File E14853.

Flammability rating: UL 94V0.

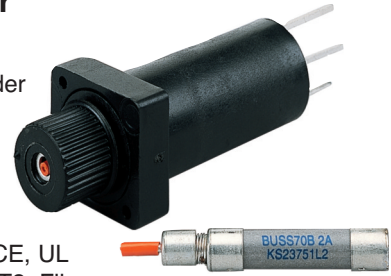

Features and benefits

- Panel mount fuse holder for 70 type fuses supplied with two screws
- Remote alarm capability

Typical applications

- Telecommunications DC power circuit protection

Catalog number — 15087

Accessories

Description: Optional color code eyelets used with fuse holder to indicate fuse amp rating.

Eyelet catalog numbers

Amp indication	Color code	Catalog numbers
15/100	Red/White	1A1706-17
18/100	Yellow	1A1706-01
1/10	Gray/White	1A1706-15
2/10	Black	1A1706-02
1/4	Violet	1A1706-03
1/4	Violet/White	1A1706-04
1/2	Red	1A1706-05
3/4	Brown	1A1706-06
1	Pink	1A1706-07
1 1/2	White	1A1706-08
2	Orange	1A1706-09
3	Blue	1A1706-10
3 1/2	Black/White	1A1706-16
5	Green/Black	1A1706-11
6	Green/White	1A1706-12
8	Brown/White	1A1706-13
10	Violet/Yellow	1A1706-14

HLS, HLT, PCT

Specifications

Description: Fuse holders for GMT indicating fuses.

Poles: 01 to 25.

Ratings:

Volts: — 60Vdc/125Vac

Agency information:

CE, UL Recognized, Guide IZLT2, File E14853, 15A (60Vdc).

Flammability rating:

UL 94V0.

Features and benefits

- Multiple configurations provide application flexibility
- Compact size saves space

Typical applications

- Telecommunications DC power circuit protection

Catalog numbers

Catalog numbers	Poles
PCT	1
HLS	1-25 see build-a-code
HLT	1-25 see build-a-code



GMT

Specifications

Description: Fast-acting fuses for use in HLT, HLS, and PCT fuse holders.

Ratings:

Volts: — 60Vdc/125Vac

Amps: — 1⁸/₁₀₀-15A

IR: — 450A@60Vdc

— 300A@125Vac

Agency information: CE, UL Recognized, Guide JFHR2, File E56412.

Flammability rating: UL 94V0.

Features and benefits

- Local and remote indication capability
- Color coded for easy amp rating identification

Typical applications

- Telecommunications DC power circuit protection

Catalog numbers

Catalog numbers	Color code	Catalog numbers	Color code
GMT-1 ⁸ / ₁₀₀ A	Yellow	GMT-3- ¹ / ₂ A	White/Blue
GMT- ¹ / ₄ A	Violet	GMT-4A	White/Brown
GMT- ³ / ₄ A	Green/Gray	GMT-5A	Green
GMT- ¹ / ₂ A	Red	GMT-7- ¹ / ₂ A	Black/White
GMT- ⁶ / ₁₀₀ A	Black	GMT-10A	Red/White
GMT- ³ / ₄ A	Brown	GMT-12A	Yellow/Green
GMT-1A	Gray	GMT-15A	Red/Blue
GMT-1- ¹ / ₂ A	White	GMT-Dummy	Gray body
GMT-1- ¹ / ₂ A	White/Yellow	GMT-X	Clear cover
GMT-2A	Orange	GMT-Y	Clear cover w/tab
GMT-3A	Blue		

Some GMT sizes may be sold in bulk pack only.

Accessories

- Spare fuse holder: catalog number TPSFH-T

GMT-A

Specifications

Description: Fast-acting fuse designed specifically for use in the Telepower 15800 (page 13-6) and TP158HC (page 13-7) fused disconnect switches.

Agency information: The GMT-A has the same ratings and agency approvals as the standard GMT fuses as shown above.

Catalog numbers

Catalog number	Color code
GMT-A	Yellow

Data Sheet: 5008

Multiple fuse holders with bus bars
Ordering information— catalog no.

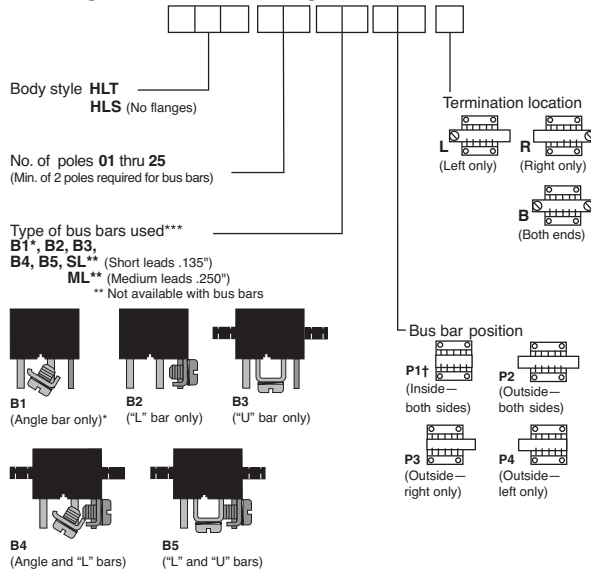

*Angle bar mounts on common or center terminals only.
**SL version is not available with bus bars.
†Minimum of 4-poles required.
***0.38 max. leads if not specified.

Data Sheet: 5010

7 Type



Specifications

Description: Fiber tube, threaded ends. Typically used on wall type main distribution frames and central battery substations.

Dimensions: See catalog numbers table and dimensions illustration.

Ratings:

Amps: — 7A

Agency information: CE

Catalog numbers

Catalog numbers	Amp rating	Lucent comcode ref. no.	Dimension A length (in)
7A-7	7	100863737	4.562
7T-7	7	100202753	4.828

Dimensions - in

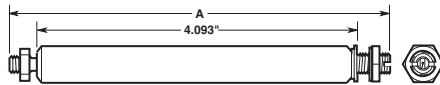

11 Type



Specifications

Description: Fiber tube, threaded ends, identical to 7 Type except for vent slots in fiber tube.

Dimensions: See dimensions illustration.

Ratings:

Amps: — 7A

Agency information: CE

Catalog number

Catalog number	Amp rating	Lucent comcode ref. no.
11C-7	7	100863745

Dimensions - in

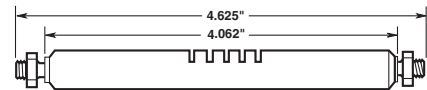

24 and WER Type



Specifications

Description: Flat, non-indicating visible link element mounted on 1 inch centers using either No. 6 or No. 10 screws.

Dimensions: See dimensions illustration.

Ratings:

Volts: — 32Vdc (1/4, 1, 3 1/2, 8, 10A)
— 60Vdc (1/2, 3/4, 1 1/2, 2, 3, 4, 5A)

Amps: — 1/4-10A

Agency information: CE, UL Recognized File E56412.

Catalog numbers

Catalog numbers	Amp rating	DC volts	Color code	Lucent comcode ref. no.	A length inches
WER-1/4	1/4	32	—	—	—
24E-1/2*	1/2	60	Red	100202894	0.20
24D-3/4*	3/4	60	Black	100202886	0.15
WER-1	1	32	—	—	—
24G-1-1/8*	1 1/8	60	White	100202910	0.20
24C-2*	2	60	Orange	100202878	0.20
24B-3*	3	60	Blue	100202852	0.15
WER-3-1/2	3 1/2	32	—	—	—
24B-4*	4	60	Yellow	100202860	0.15
24F-5*	5	60	Green	100202902	0.15
WER-8	8	32	—	—	—
WER-10	10	32	—	—	—

*Designed to comply with Bellcore Technical Reference TR-TSY-000799 Issue 1, Dec. 1988.

Dimensions - in

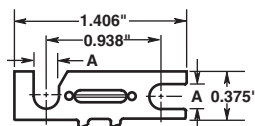

74 Type



Specifications

Description: Fast-acting 0.281" x 1.25" cylindrical fuse designed to comply with Lucent specification KS23753. High current companion to 70 Type fuse.

Dimensions: See dimensions illustration.

Ratings:

Volts: — 60Vdc

Amps: — 1 1/4-20A

Agency information: CE, UL Recognized File E19180.

Catalog numbers

Catalog numbers	Amp rating	Lucent comcode ref. no.	Code/ list no.
74A-1-1/4	1 1/4	102630290	KS23753-L1
74G-2	2	103064952	KS23753-L7
74B-3	3	102630308	KS23753-L2
74H-4	4	103264669	KS23753-L8
74C-5	5	102630316	KS23753-L3
74J-7-1/2	7 1/2	103228425	KS23753-L9
74D-10	10	102630324	KS23753-L4
74E-15	15	102630332	KS23753-L5
74F-20	20	102630340	KS23753-L6

Dimensions - in (mm)

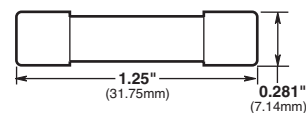

75 Type

Specifications

Description: Cylindrical with leads, designed to provide protection against currents resulting from the application of foreign voltages. Application for data sets and telephones.

Dimensions: See dimensions illustration.

Ratings:

Volts: — 135Vac/220Vdc (440Vdc@0.007A)

Amps: — 0.007-0.230A

Agency information: CE

Catalog numbers

Catalog numbers	Amp rating	Lucent comcode ref. no.	Code/ list no.
75C	0.007	103260816	KS23825-L3
75F	0.063	104172861	KS23825-L6
75B	0.115	102732112	KS23825-L2
75D	0.129	104013180	KS23825-L4
75A	0.200	102660008	KS23825-L1
75E	0.230	104015292	KS23825-L5

Dimensions - in (mm)

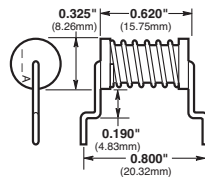

76 Type

Specifications

Description: Cylindrical with leads, designed to provide protection against currents resulting from the application of foreign voltages. Application for data sets and telephones.

Dimensions: See dimensions illustration.

Ratings:

Volts: — 135Vac/440Vdc

Amps: — 0.012-0.412A

Agency information: CE

Catalog numbers

Catalog numbers	Amp rating	Lucent comcode ref. no.	Code/ list no.
76D	0.012	103798245	KS23825-L10
76B	0.191	102965688	KS23825-L8
76A	0.231	102810181	KS23825-L7
76C	0.412	103656625	KS23825-L9

Dimensions - in (mm)

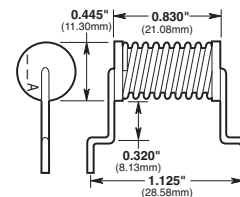

80 Type

Specifications

Description: A fuse designed for high reliability applications where high ambient temperatures, low circuit voltages, low power dissipation and low contact resistance are prime considerations. The 80 Type is a visual indicating fuse with remote electrical alarm capability. UL Recognized, Guide JDYX2, File E19180.

Dimensions: See dimensions illustrations.

Ratings:

Volts: — 160Vdc

Amps: — ½-5A

Agency information: CE, UL Recognized File E19180.

Catalog numbers

Catalog numbers	Amp rating	Color code	Lucent comcode ref. no.	Code/ list no.
80G-½	½	Red	103839916	KS23824-L6
80M-1-½	1½	White	408078657	KS23824-L8
80B-2	2	Orange	103752150	KS23824-L2
80C-3	3	Blue	103752168	KS23824-L3
80D-5	5	Green	103800637	KS23824-L4

Dimensions - in (mm)

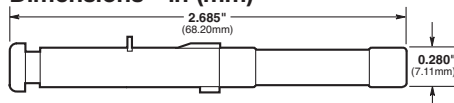

Surge Protection Made Simple™

UL 508A Applications

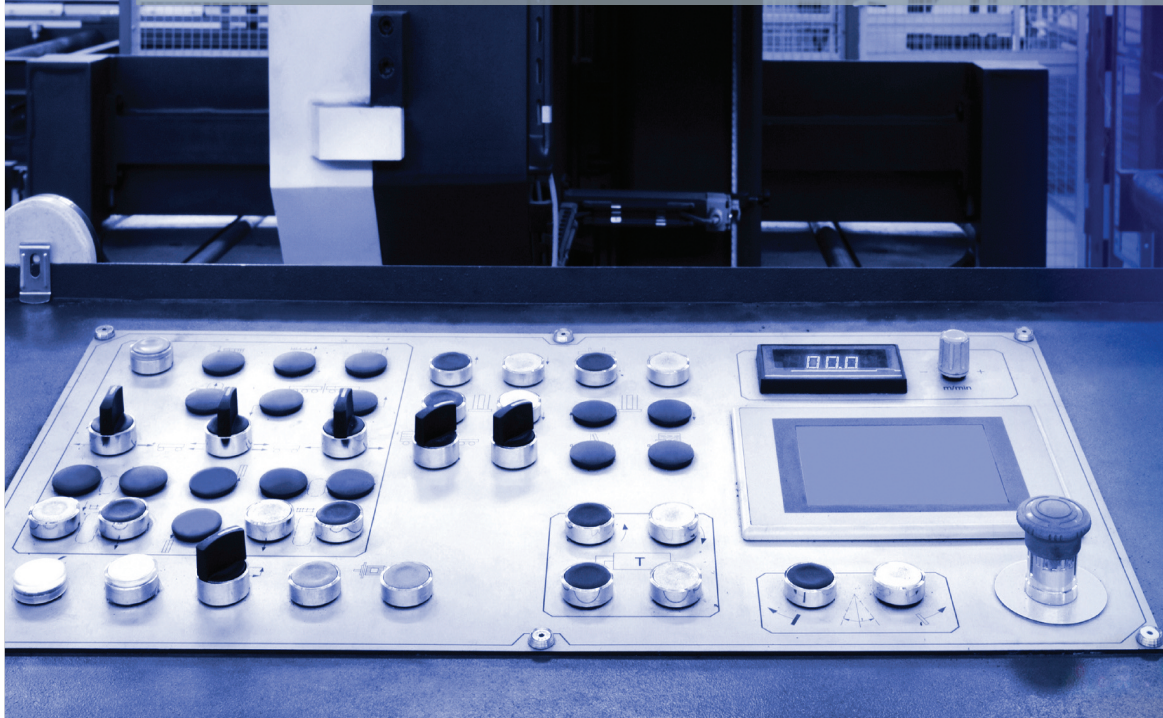

Comprehensive UL 1449
3rd Edition recognized Busmann
series surge protection solutions
for North American applications.

EATON

Powering Business Worldwide