

### Aluminum Electrolytic Capacitors





## Contents

<u>1. Introduction</u>	· · · · · 1
<u>2. Summary of Capacitors</u>	· · · · · 2
2-1 Principle of Capacitors	· · · · · 2
2-2 Types of Electrolytic Capacitors	· · · · · 4
2-3 Construction of Aluminum Electrolytic Capacitors	· · · · · 5
<u>3. Production of Aluminum Electrolytic Capacitors</u>	· · · · · 6
3-1 Electrodes and Dielectric Film of Aluminum Electrolytic Capacitors	· · · · · 6
3-2 Production method Aluminum Electrolytic Capacitors	· · · · · 7
<u>4. Reliability of Aluminum Electrolytic Capacitors</u>	· · · · · 10
4-1 Aluminum Electrolytic Capacitor Failure	· · · · · 10
<u>5. Use technique of Aluminum Electrolytic Capacitors</u>	· · · · · 13
5-1 Life Design	· · · · · 13
5-2 Circuit Design	· · · · · 15
5-3 Installation Design	· · · · · 19
5-4 Operation and Storage	· · · · · 22
5-5 Operation and Storage	· · · · · 25
<u>6. Major Applications</u>	· · · · · 26
6-1 Power Supply Circuits	· · · · · 26
6-2 Inverters	· · · · · 27
6-3 ECU for Automotive	· · · · · 29

# 1. Introduction

Capacitor is electronic component constructed electronic circuit. There are a variety of capacitors which have various materials and construction. Typical classification of capacitors shows in Fig.1. This technical guide summarizes the outline and use technique of aluminum electrolytic capacitor which is increasing in accordance with miniaturization of electronic components.

The type of capacitors can be selected from the circuit characteristics. Generally, you can select it by capacitance and voltage in Table-1. About what each type have in common, reliability and price will be considered as well as performances such as frequency characteristics and temperature dependence, etc. shown in Table-2.

We have many types of capacitors trying to meet various customer's needs. Capacitors (especially aluminum electrolytic capacitors) are sensitive to operating condition. We would be happy if this technical guide is helpful for better understanding, and if we could consult with you about the technical contents.

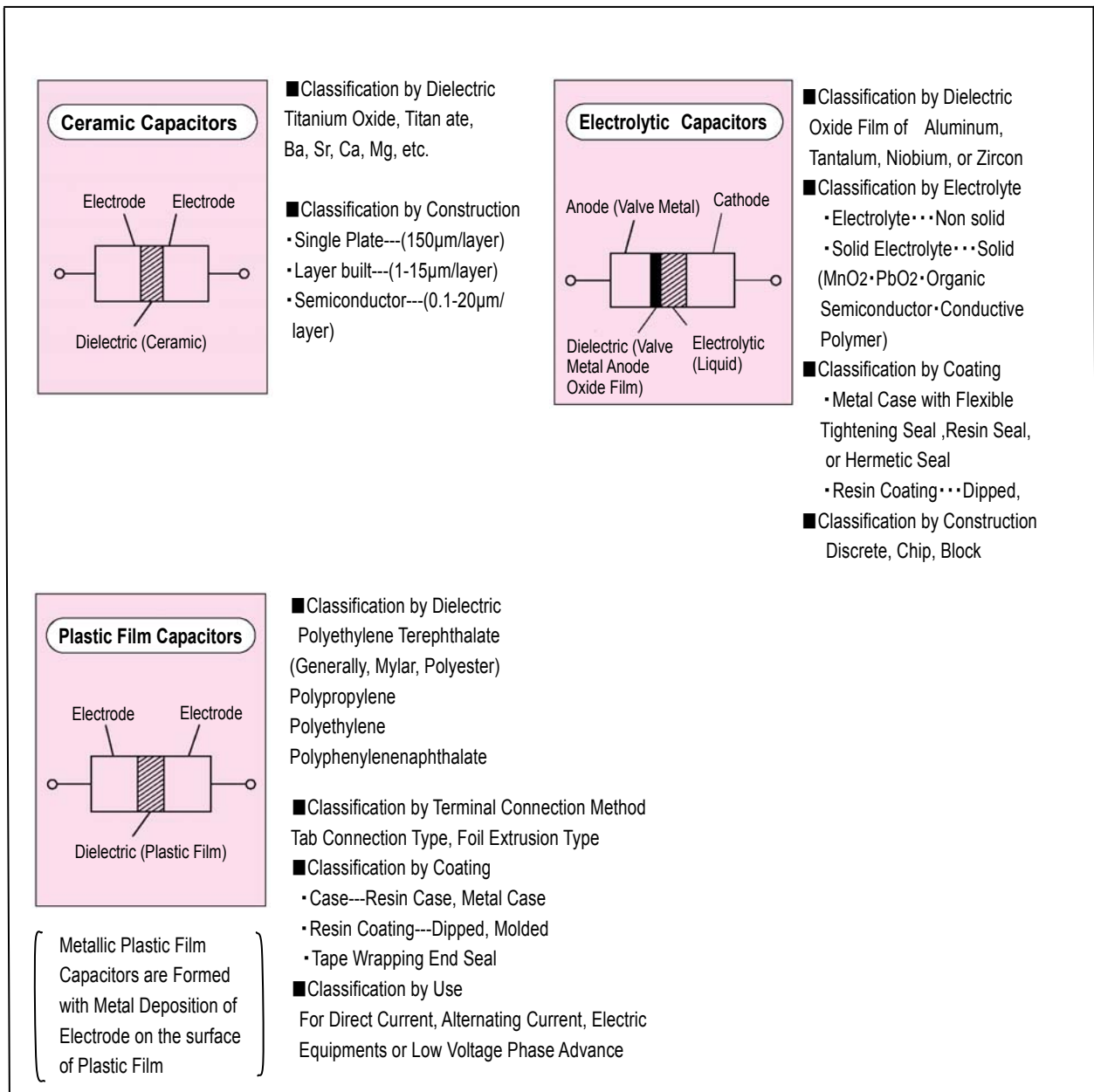
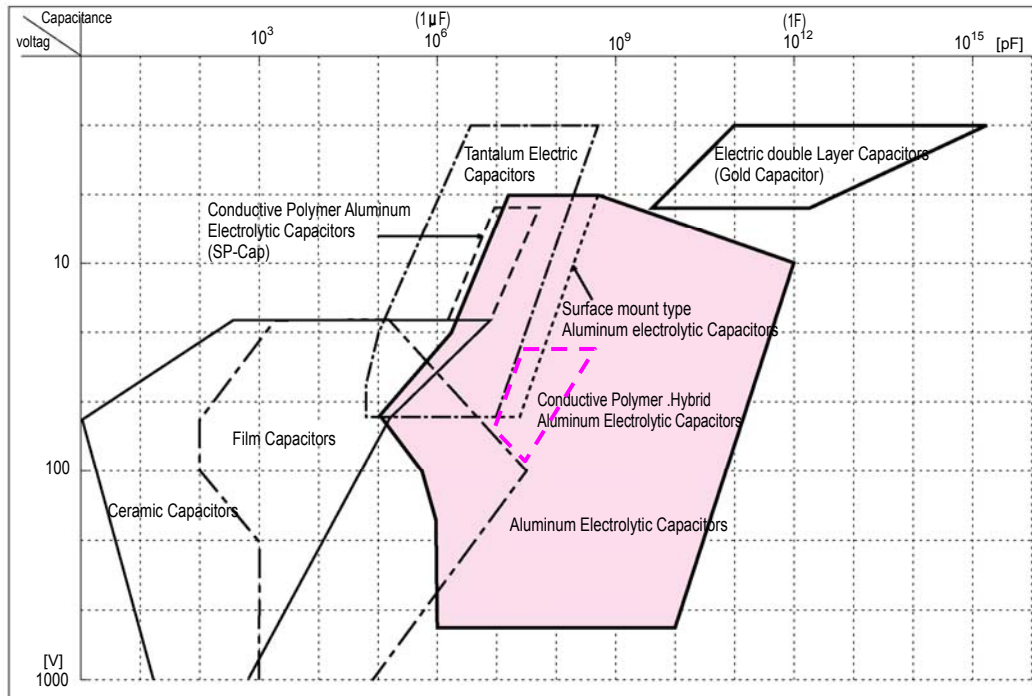

Fig.1 Typical Classification of Fixed Capacitors



**Table-1 Capacitance • Voltage range of various capacitors**



Note) It shows general, there are other products with capacitance and voltage.

**Table-2 Characteristics of various capacitors**

Representative Fixed Capacitors		Dielectric Constant $\epsilon_s$	Thickness of Dielectric d( $\mu$ m)	Working Voltage V(V.DC)	Product Pressure Capacitance Stability			Characteristics
					Temperature Dependency* (-40°C / +85°C)	Bias Dependency	Frequency Dependency	
Electrolytic Capacitors	Aluminum Electrolytic Capacitors	8~10	0.03~0.7	~450	-20~-10 +8~+15	Low	High	Compact and. Large Capacitance. Inexpensive per Capacitance. Temperature/Frequency Dependency is high.
	Conductive Polymer. Hybrid Aluminum Electrolytic Capacitors	8~10	0.03~0.7	~100	-15~-10 +5~+10	Low	Low	Miniaturization, Ultra Low ESR, High voltage, High Reliability.
	Tantalum Electrolytic Capacitors (Solid)	23~27	0.04~0.5	~50	-4~-2 +4~+7	Medium	Medium	Compact and relatively large capacitance with high reliability. Temperature Dependency is low. Relatively expensive.
Ceramic Capacitors	Ceramic Capacitors of High Dielectric Series	11000 ~ 18500 (40000)	Single Plate, 150~ Layer Built	Single Plate, 0.5K~40K Layer Built	-60~-40 -80 -60	High	Low	Superior in Frequency Feature but Bias/Temperature Dependency is High. Inexpensive with High Reliability.
	Ceramic Capacitors For Temperature Compensation	~ 160	0.5~15 Semiconduct or 0.1~20	2.5~3.15K Semiconduct or 16~50	Temperature Dependency at option	Low	Low	Both Frequency Feature and Bias Dependency are good. Capacitance Is small.
Plastic Film Capacitors	Polyethylene Terephthalate Film Capacitors	3.0~3.3	1.5~25	35~500	-5~-3 +2.5~+4	Low	Low	Best Workability among Films, despite of small size, large Capacitance is obtainable, but Inferior in Characteristics. Most popular among Film Capacitors.
	Polypropylene Film Capacitors	2.1~2.2	4~22	50~600	+1.5~+2.5 -1.5~-2.5	Low	Low	Suitable for high Frequency large Current with- superior Dielectric Loss Tangent and Voltage Resistance. Relatively inferior in Film Productivity and heat Resistance.
	Polyphenylene Sulfide Film Capacitors	2.8~3.4	2~30	25~500	Around+1 Around-1	Low	Low	Superior in both Heat Resistance and Feature. Coefficient of Water Absorption and Temperature Dependency are also low with gradual good Stability.

\* A temperature dependence is expressed with the rate of change to 20°C

## 2. Summary of Capacitors

### 2-1 Principle of Capacitors

Capacitor consists of two metal plates with good transmittance in parallel, and dielectric (insulator) which does not transmit electricity between them. (Fig 2)

The name of capacitors is decided by the kinds of electrode material and dielectric.

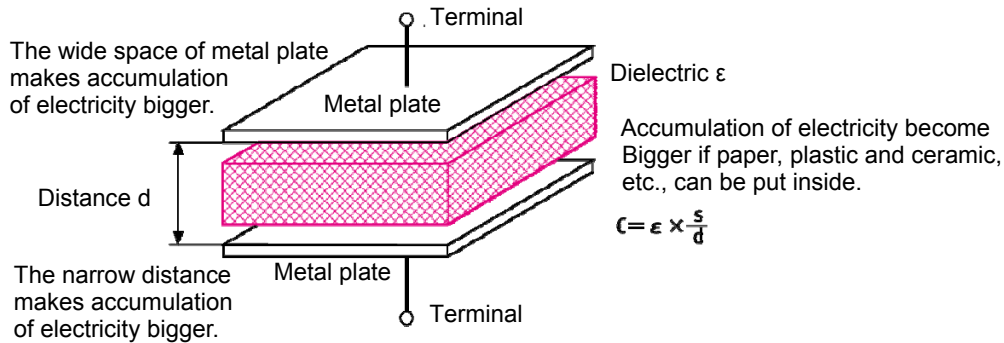

**Fig.2 Principle of Capacitor**

Electrolytic capacitors are distinguished from other capacitors by the uniqueness of their electrode materials and dielectric. Fig.3 shows the principle diagram of electrolytic capacitor.

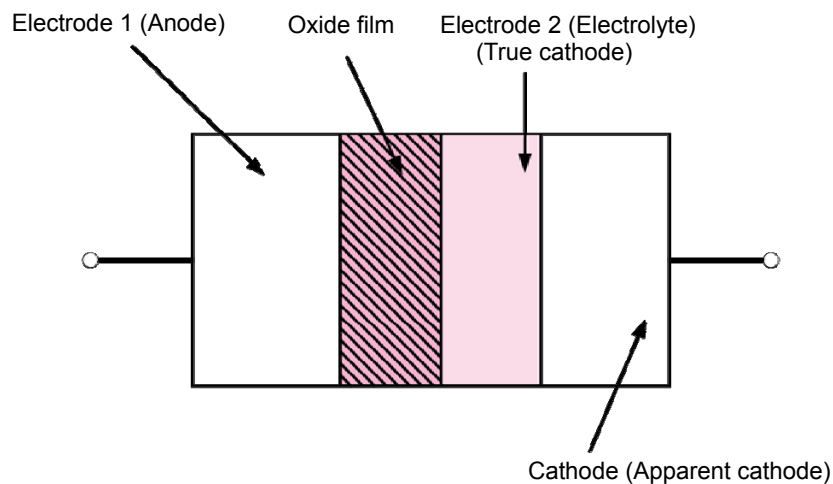

**Fig.3 Principle Diagram of Electrolytic Capacitor**

Electrolytic capacitor names after using oxide film formed electrochemically on electrode surface as dielectric.

Aluminum (Al), tantalum (Ta), niobium (Nb), titanium (Ti), zirconium (Zr), hafnium (Hf) and other metals can form a fine, highly isolative oxide currently, the only three metals in practical application are aluminum, tantalum and niobium.

Oxide film formed on the surface of electrode 1 becomes an electrical insulator and functions as a dielectric only when the electrode on which formed becomes anode.

Therefore, electrolytic capacitors are, in principle, capacitors with polarity.

★ **Point : Electrolytic capacitors have polarity.**

## 2-2 Types of Electrolytic Capacitors

The types of capacitors in practical application are those shown in Fig.4.

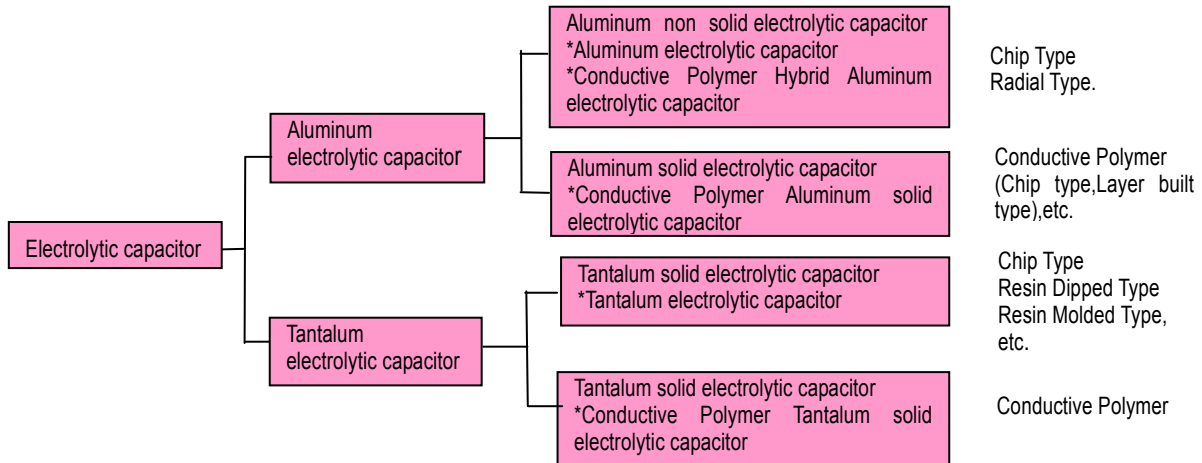

**Fig.4 Types of Electrolytic Capacitors**

Since the applications of tantalum non solid electrolytic capacitors are limited and extremely specialized and they are produced in only small numbers, aluminum electrolytic capacitors (non solid and solid) and tantalum solid electrolytic capacitors (tantalum electrolytic capacitors below) may be considered to be the only two main types of electrolytic capacitors.

**Table-3 Features and Differences**

	<b>Aluminum Electrolytic Capacitors</b>	<b>Conductive Polymer Hybrid Aluminum Electrolytic Capacitors</b>	<b>Tantalum Electrolytic Capacitors</b>
<b>Voltage range</b>	2 V.DC to 500 V.DC	25 V.DC to 80 V.DC	2 V.DC to 50 V.DC
<b>Capacitance range</b>	0.1 $\mu$ F to 100000 $\mu$ F	10 $\mu$ F to 330 $\mu$ F	0.047 $\mu$ F to 2200 $\mu$ F
<b>Miniaturization</b>	Advantageous in high capacitance range	Advantageous in high frequency range	Advantageous in low capacitance range
<b>tan <math>\delta</math></b>	High	Low	Low
<b>Leakage current</b>	Relatively large	Relatively small	Relatively small
<b>Temperature characteristics</b>	Not very good	Good	Good
<b>Frequency characteristics</b>	Not very good	Good	Good
<b>Failure mode</b>	Wear failure (limited life), open	Wear failure (limited life), open	Random failure, increase in leakage current, short circuit
<b>Solder heat resistance</b>	Relatively weak	Relatively weak	Relatively strong
<b>Voltage delating</b>	No big influence on reliability (life)	No big influence on reliability (life)	Influence on failure rate (low voltage is good)
<b>Ripple resistance</b>	Relatively strong	Relatively strong	Can not take large ripple current
<b>Reverse voltage resistance</b>	Can not take it (*Correspondence possible in some series)	Can not take it	Can not take it
<b>Surge</b>	Relatively strong	Relatively strong	Strong
<b>Price</b>	Relatively inexpensive	Relatively expensive	Relatively expensive

A liquid electrolyte, while tantalum electrolytic capacitors use a solid electrolyte.

These structural differences in aluminum electrolytic capacitors and tantalum electrolytic capacitors have a large influence on their performance and reliability.

The biggest difference of them is in their electrolytes (liquid•solid).

Such properties as temperature characteristic and frequency characteristic are not as good with the liquid electrolyte as with the solid electrolyte because the variation in conductivity is great. In contrast, the recoverability of the oxide film is not as good with solid electrolytes as it is with liquid electrolytes, and so the development of a flaw in the oxide film could easily result in a failure mode such as an increase in leakage current or a short circuit.

Solid electrolyte capacitors do not have as good a ripple current resistance and charge-discharge resistance, and do not stand up as well to reverse current due to the difference in recoverability.

The life of aluminum non solid electrolyte capacitors is limited because the electrolyte gradually permeates through the seal and evaporation in recoverability.

Because the electrolyte gradually permeates through the seal and diffuses, causing the capacitor to dry up and lose capacitance and resulting in an open condition.

Solid capacitors, on the other hand, have an almost permanent life because their electrolyte does not evaporate.

★ Point : Aluminum electrolytic capacitor have a life.

The hybrid type which used the conductive polymer and the electrolysis solution for the electrolyte is also produced commercially, and the lineup also of the capacitor excellent in performance and quality is carried out.

### 2-3 Construction of Aluminum Electrolytic Capacitors

The construction of aluminum electrolytic capacitors is shown in Fig.5

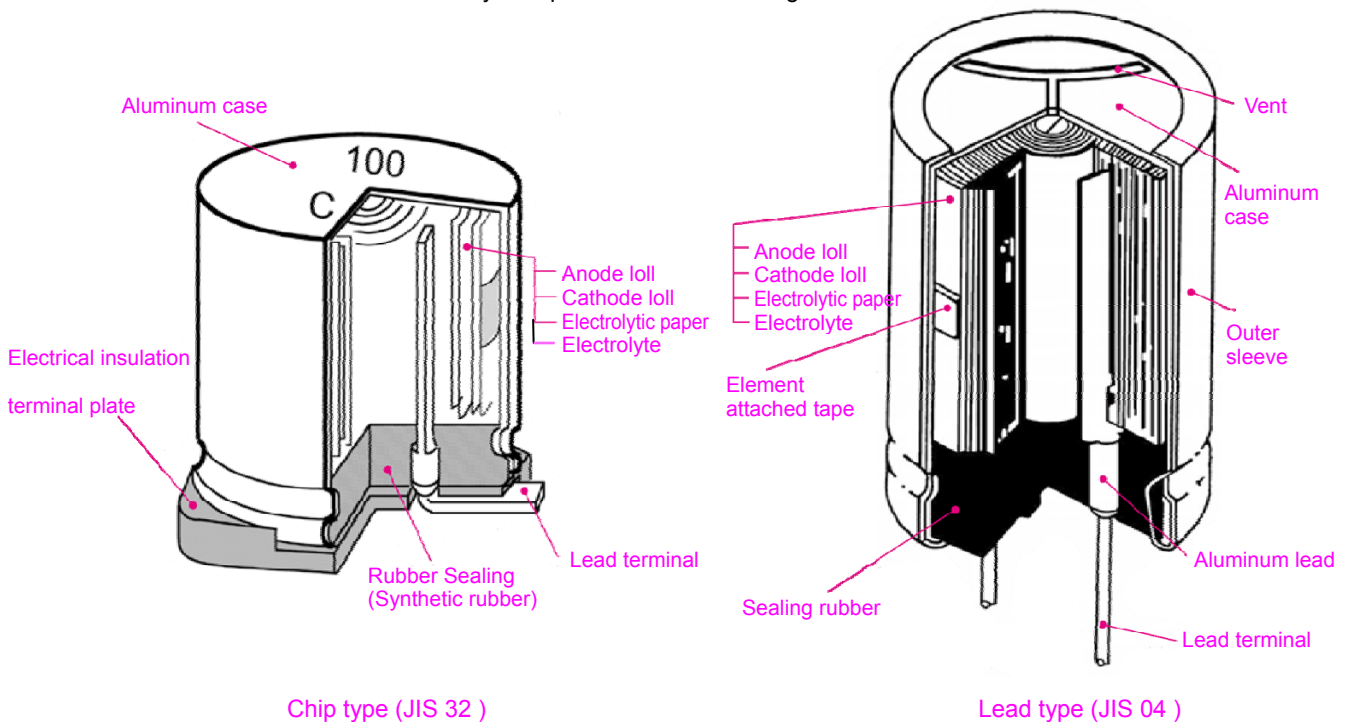

Fig.5 Structure of Aluminum Electrolytic Capacitor



### 3. Production of Aluminum Electrolytic Capacitors

#### 3-1 Electrodes and Dielectric Film of Aluminum Electrolytic Capacitors

##### Aluminum Electrode Foils

To increase the surface area, the surface of aluminum electrode foils is electrochemically roughened (etched).

##### [ Etched Foil for Low Voltage ]

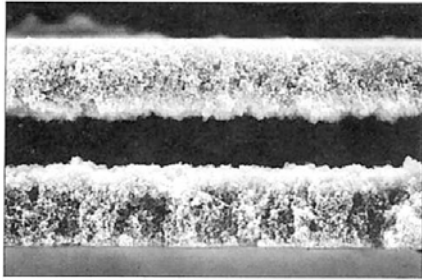

(Cross section) (X500)

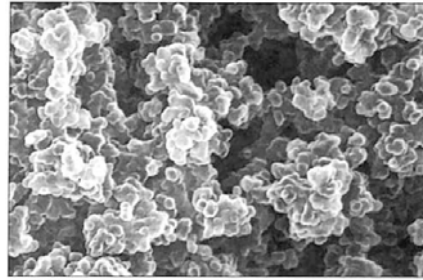

(Replica) (X10,000)

For low voltage, a sponge-like pitted surface is obtained by AC etching.

##### [ Etched Foil for High Voltage ]

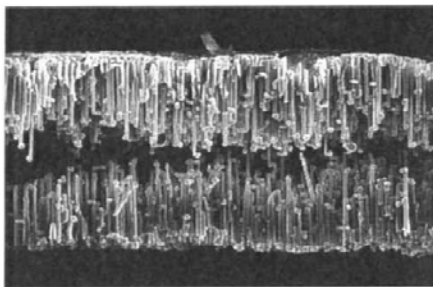

(Cross Section) (X500)

For high voltage, a tunnel-like pitted surface is obtained by DC etching.

##### [ Dielectric Foil ]

An aluminum oxide film is electrochemically on the etched aluminum foil to serve as the dielectric.

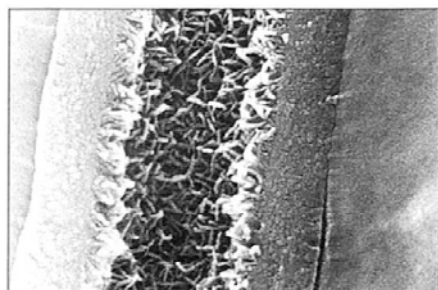

(X50,000)

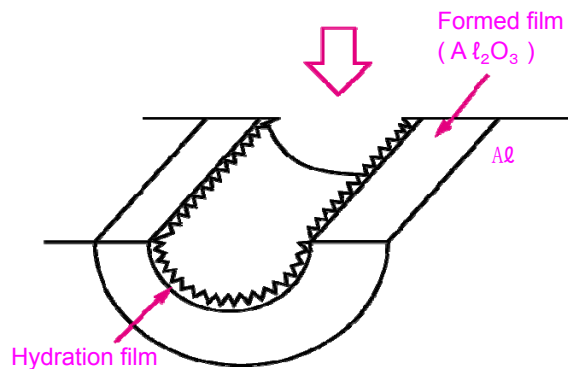

The oxide film in the figure is a cross section of formed film in the pits of etched foil in the pits of etched foil for medium to high voltage.

### 3-2 Production method Aluminum Electrolytic Capacitors

#### Etching (1) Anode Aluminum Foil

Aluminum foil normally 40 to 110  $\mu\text{m}$  thick and more than 99.9% pure is used for the anode foil.

#### (2) Etching

This process electrochemically roughens the smooth surface of the rolled aluminum foil to increase its effective surface area. The ratio of the capacitance of the smooth foil to that of the etched foil at a certain forming voltage is referred to as multiplying factor, and it normally reaches tens times to hundreds times fold.

Most companies are placing emphatic.

#### Forming (3) Forming

In this process, which greatly determines the performance of the capacitor, electrolytic is performed in an electrolyte (differs from the electrolyte impregnated in element with respect to purpose and composition and is normally referred to as formation liquid) with the etched foil as the anode (Anodic oxidation), thereby electrochemically forming an aluminum oxide film on the aluminum foil surface to serve as the dielectric.

One aspect of this capacitor that distinguishes it from others is the ability to change the withstand voltage

( i. e. , thickness of the aluminum oxide film) and the capacitance as required by the intended use by adjusting the forming

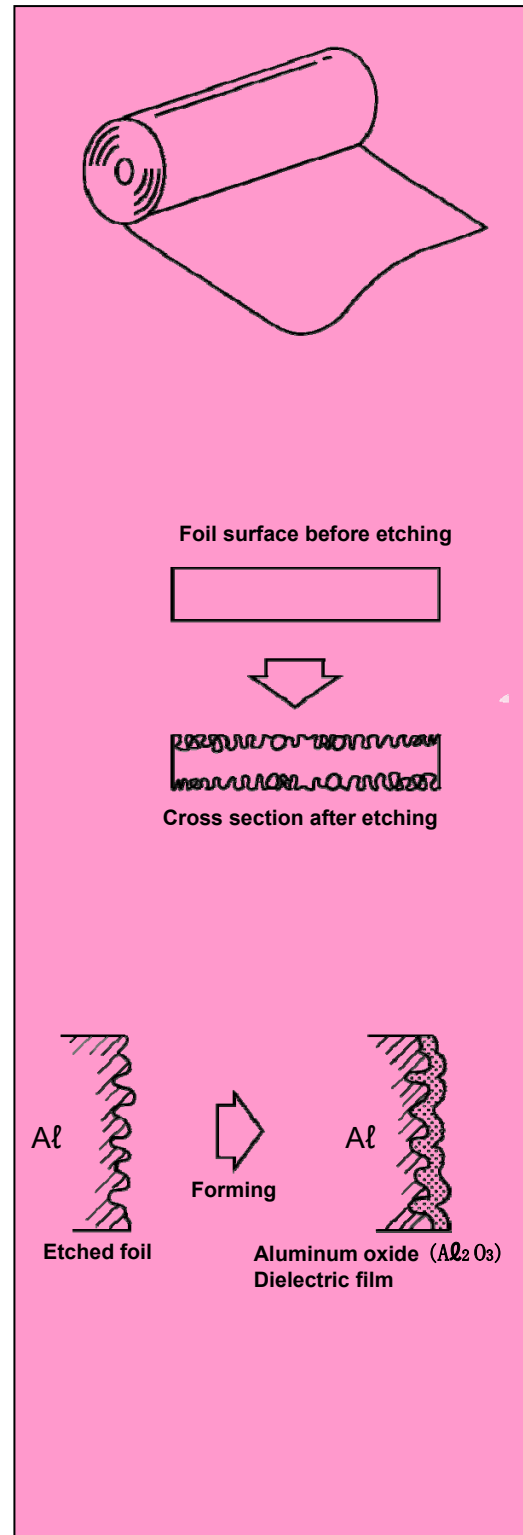

### Slitting (4) Slitting (5) Attaching Lead (6) Winding

The formed electrode foils are cut to prescribed dimensions depending. On the required capacitance of the product, and then after attaching the leads, the anode foil is wound up with the cathode foil and the electrolytic paper (Separator) in between to form a cylinder.

### Winding (7)Winding

- The electrolytic paper is specially made for electrolytic capacitors and serves two functions.

- It separates the anode foil and the cathode foil so they will not short - circuit.
- It is saturated with the electrolyte and retains it. For this reason, a superior paper of uniform thickness, density, water absorption, tensile strength, etc, is required.

The principal materials used

### Only Hybrid Capacitors (8) Forming of Section

It is the process of restoring the part in which transformation is not formed, and the part where transformation is insufficient. The leakage current is stabilized.

### (9) Polymer Formation

It is the process of forming polymer in an element.

The characteristic of ESR and capacitance is pulled out.

### Impregnation (10) Impregnation

Impregnation is the process of saturating the wound element with electrolyte.

The type of electrolyte used varies with the characteristic application of the product.

### \*About the Electrolyte

The electrolyte impregnated in the element is referred to as driving-electrolyte and performs the following two functions

- It impregnates and adheres to the surfaces of the anode and cathode foils to extract 100% of their capacitance (essentially a cathode action,)

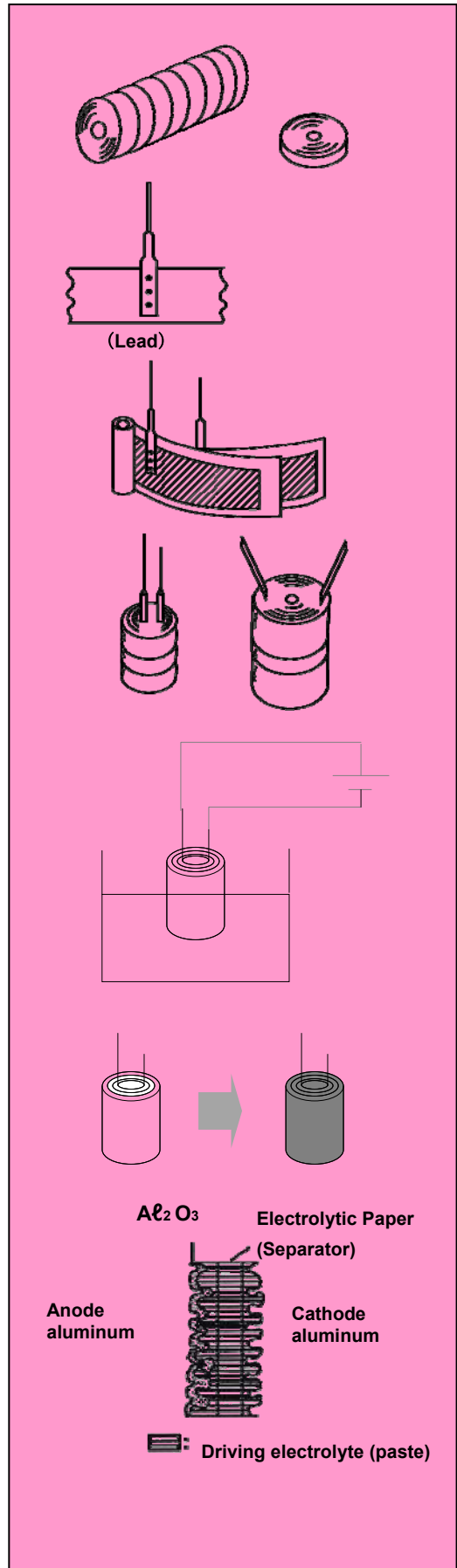

b. Repairs defects in the anode oxide film.  
 The characteristics of electrolyte greatly influence the temperature characteristic, frequency characteristic, high temperature load life, etc. of the capacitor, and so an electrolyte with a composition different from that of the formation liquid and one that also satisfies economic, other requirements is, of course, required.

### Assembly (11) Assembly

Wound unit impregnated with electrolyte already have the function of a capacitor, to avoid deterioration of the characteristics of the capacitor due to evaporation or moisture absorption of the electrolyte, they must be inserted in a metal case and sealed with rubber packing or other sealing material. The capacitor also receives a vinyl sleeve noting such necessary information as polarity, rated voltage, capacitance and use temperature.

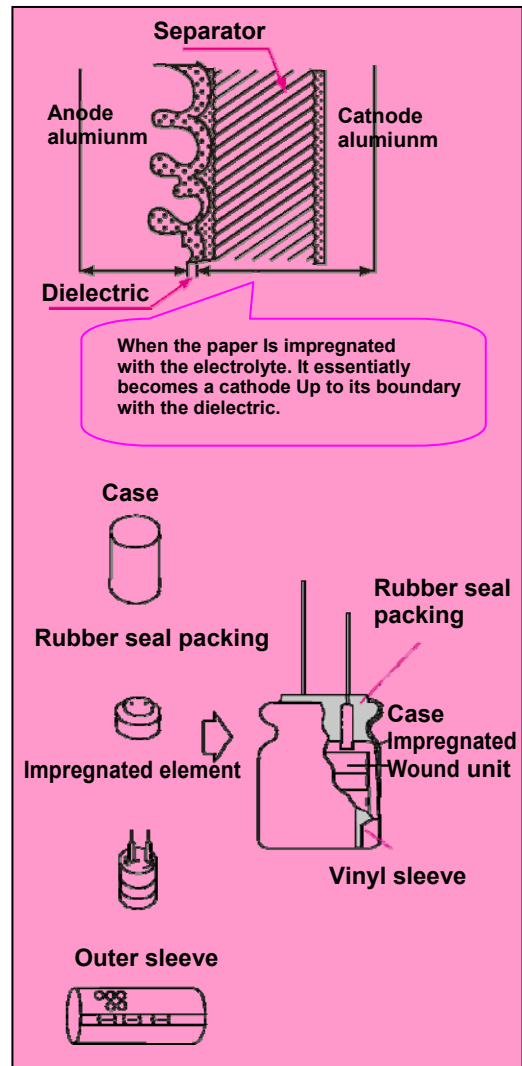

### Reforming (12) Reforming (Aging) (Aging)

This process impresses a prescribed voltage on the assembled product to stabilize its characteristics.

Upon assembly, the slit surface of the electrodes, lead connections and other unformed places and places where the film has been damaged must be reformed.

This process also permits confirmation of the withstand voltage and screening of defective products. It is important in raising the reliability of capacitors in the initial stages so that they will yield stable operation from the beginning when assembled in devices.

### Seal processing (13) Only SMD Type

After sealing the heavens side of an aluminum case in a display (Rated voltage code, Cap. Lot No., negative pole display.) about a field mounting article, lead processing is carried out, after carrying out seat board insertion.

### Completion Inspection (14) Completion Inspection

Products that have undergone reforming are inspected for capacitance,  $\tan \delta$  leakage current, external appearance, etc., to ensure they will perform as required, and then they are packaged.

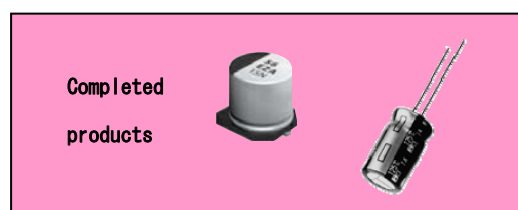

## 4. Reliability of Aluminum Electrolytic Capacitors

As you see from manufacturing process, capacitors are similar to radial type.

Please note, the difference is Surface Mount Type Aluminum Electrolytic Capacitors reliability depend upon reflow methods and conditions.

### 4-1 Aluminum Electrolytic Capacitor Failure

Failure modes are roughly classified as follows.

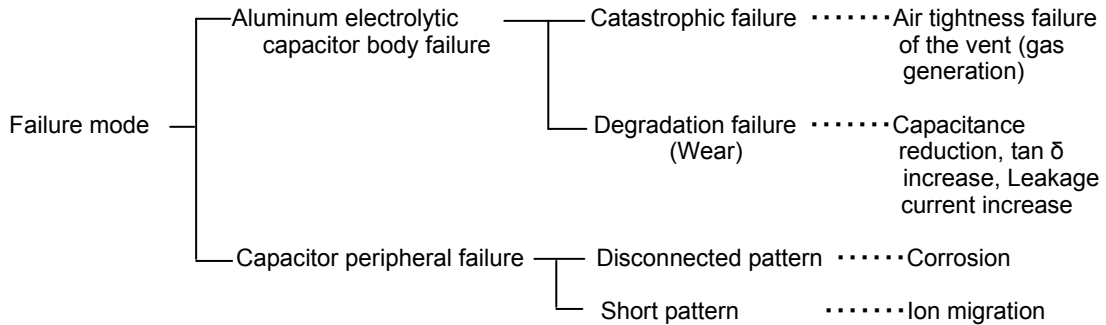

Degradation failure can not be found for most other capacitors.

Aluminum electrolytic capacitors increase the failure rate by passing time shown in Fig.6, all become open.

In catastrophic failure, the function of the capacitor is completely lost, so it is easily judged as failure, but since the characteristics gradually deteriorate in degradation failure, the stage at which it is judged as a failure will vary greatly with the performance required by the electronic device in which it is used. In the case of degradation failure, variation from the standard values in our delivery specifications and catalog based on JIS-C5141 is judged as failure.

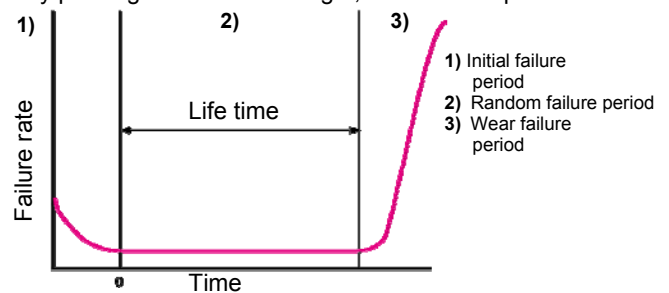

Fig.6 Degradation failure of aluminum electrolytic capacitor

Table-4 Failure mode • mechanism of aluminum electrolytic capacitor

Failure modes	Failure mechanism (internal symptom)	Production cause	Use cause
Air tightness failure of sealing part	Increase in internal pressure	Increase in internal temperature	Over voltage impressed
Capacitance reduction	Reduced anode foil Capacitance		Excessive ripple current
tan δ increase	Reduced cathode foil Capacitance		Reverse voltage applied
Leakage current increase	Deterioration of oxide film	Defect of oxide film	Severe charging-discharging
	Electrolyte dry-up	Insufficient electrolyte	AC voltage applied
Short circuit	Insulation breakdown of film or electrolytic paper	Metal particles adhering	Heating part in back or neighbor
	Leads improperly connected	Burr(s) on foil or leads	Used at high temperatures
Open	Corrosion	Leads improperly connected	Used for long period
	Infiltration of Ct	Mechanical stress	Stress applied to leads
Disconnected short of peripheral pattern	Electrolyte leakage	Excessive electrolyte	Severe reflow condition
	Big change of sealing material		Cleaner (organic) used
			Adhesive used
			Coating material used

☆ Point : Mounting condition greatly influences on the reliability of capacitors.



### (1) Airtightness failure of the vent (gas generation)

Aluminum electrolytic capacitors have characteristics which quickly repair film defects by the mechanism shown in Fig.7. However, as in a battery, oxidation at the anode will cause reduction at the cathode, resulting in the generation of hydrogen gas (H<sub>2</sub>).

When used under conditions within the guaranteed ranges noted in the catalog or delivery specifications, the hydrogen gas generated is extremely small, and any that is generated is dissipated by the depolarization action of the electrolyte or through the sealing element, so there is no problem, but if used under conditions, such as temperature, over voltage, reverse voltage and excess ripple current, exceeding the guaranteed ranges, damage to the film will increase, causing a sudden increase in the amount of hydrogen gas generated by the self-repairing action. This will cause the internal pressure to rapidly increase and may cause the aluminum case to swell, the vent to operate, or some other external change.

### (2) Open Failure

Open failure can occur due to any of the following conditions.

- 1) Mechanical damage to the lead conditions.
- 2) Corrosion due to the infiltration of a corrosive material.
- 3) Evaporation of electrolyte due to operation of the vent.
- 4) Final stage of gradual deterioration.

The first one occurs due to improper connection at the time of production or the lead being subjected to excessive stress, vibration, or impact. The second

one occurs when chlorine ions (Cl<sup>-</sup>) enter during production, or the capacitor is cleaned with a chlorine cleaner or is reinforced with a resin containing chlorine compounds and chlorine substances enter the capacitor.

These corrode the leads or electrode foils until an open condition results.

The third one occurs when internal electrolyte evaporates causing the capacitor to dry up. This reduces the capacitance and increases tan δ.

The fourth one occurs at the end of the life of the capacitor through the process of deterioration ; i.e., the final stages of degradation failure in which the electrolyte gradually penetrates through the seal causing the capacitance to drop and tan δ to increase.

### (3) Short circuit

We use electrolytes with excellent film repairing characteristics in our aluminum electrolytic capacitors, so any film defects that do occur are quickly repaired and local concentrations of current avoided.

Therefore, catastrophic failures such as short circuits or breakdown are normally very rare.

However if defects such as metal or other conductive particles or burrs on electrode foils or leads are allowed to pass in production, or if, during use of the capacitor, stress is applied to the leads or it is subjected to undue vibration or shock, the capacitor's separator paper may be damaged allowing the anode and cathode foils to come in contact and result in a short circuit.

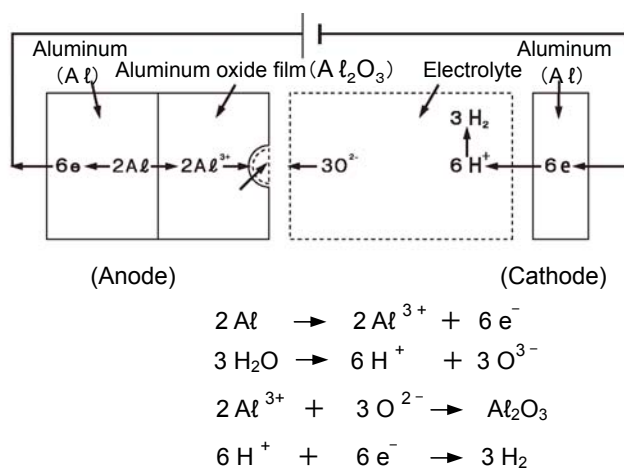
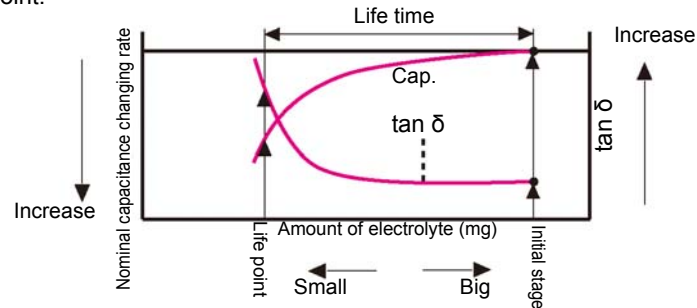

**Fig.7 Self-repairing Mechanism**

#### (4) Degradation failure (life)

Fig.8 shows the relation of electrolyte amount and capacitance  $\tan \delta$ . It has changed (Capacitance reduction and  $\tan \delta$  increase) according to aluminum case, contact part of sealing material and lead wire, and penetration evaporation of electrolyte from sealing interface.

Judgment of degradation depends on the product type, so that catalog or delivery specifications should be referred. for capacitance and  $\tan \delta$  in Fig. 8, the characteristics are drastically changed when the electrolyte amount reduces to a certain point.



**Fig.8 Characteristics degradation & Electrolyte amount**

#### (5) Failure of a capacitor periphery

Aluminum electrolytic capacitors may influence on its periphery of PCB (especially, wiring pattern), not only capacitor itself.

Electrolytic used is gradually penetrated and evaporated below the capacitor through one of the two routes, and the following phenomena may happen.

- 1) Disconnected pattern the pictures of Fig.10 show the capacitor which was forced to drop electrolyte, applied 32V/mm voltage and left for 20 hours at 40°C 90 to 95%R.H. (a)
- 2) Short pattern where the electrolyte adheres the patterns which have potential difference over two, copper or silver of pattern materials may make ion migration. (b)

This phenomenon varies a lot depending on environment condition (especially, humidity and dew condensation should be careful) and intensity of electric field.

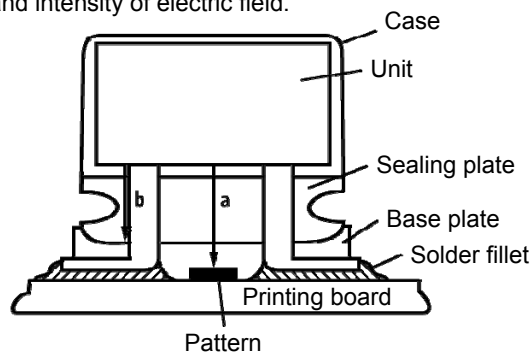

**Fig.9 Electrolyte penetration of Aluminum electrolytic capacitor**

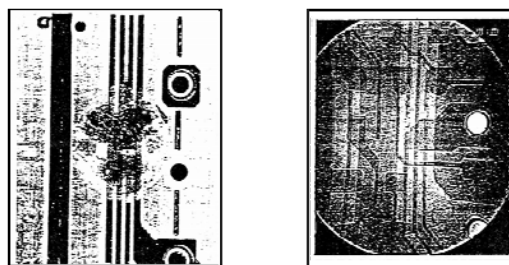

(a)

(b)

**Fig.10 Corrosion at electrolyte dropping test**

## 5. Use technique of Aluminum Electrolytic Capacitors

Please read the following & use it properly in order to show full performance and keep the stable quality of surface mount type aluminum electrolytic capacitor.

### 5-1 Life Design

As repeated, aluminum electrolytic capacitor is the limited life component. Temperature is only a key for life under the normal use condition. Other factors such as voltage and mounting conditions shown in 5-2 become the reason to shorten the life under the abnormal condition, but don't cause any problems under the normal condition.

### How to calculate the life from temperature

The dissipating speed of electrolyte changes with the rate doubling with every 10°C increase in temperature, this "double rule with 10°C" will be applied between 40°C and about 140°C. Therefore, expected life at operating temperature can be described in equation (1). for quick calculation, see Fig.11

$$L = L_0 \times 2^{\frac{T_0 - T}{10}} \quad (\text{Equation 1})$$

- L : Expected life in actual use [hour]
- T : Actual ambient temperature + temperature rise due to ripple current [°C]
- L<sub>0</sub> : Guaranteed life of capacitor (hour)
- T<sub>0</sub> : \* Product that defines the endurance by superimposing the rated ripple current.  
Upper category temperature of capacitor + temperature rise (5°C) due to rated ripple current [°C]
- \* Product that defines the endurance by applying a rated voltage  
Upper category temperature of capacitor [°C]

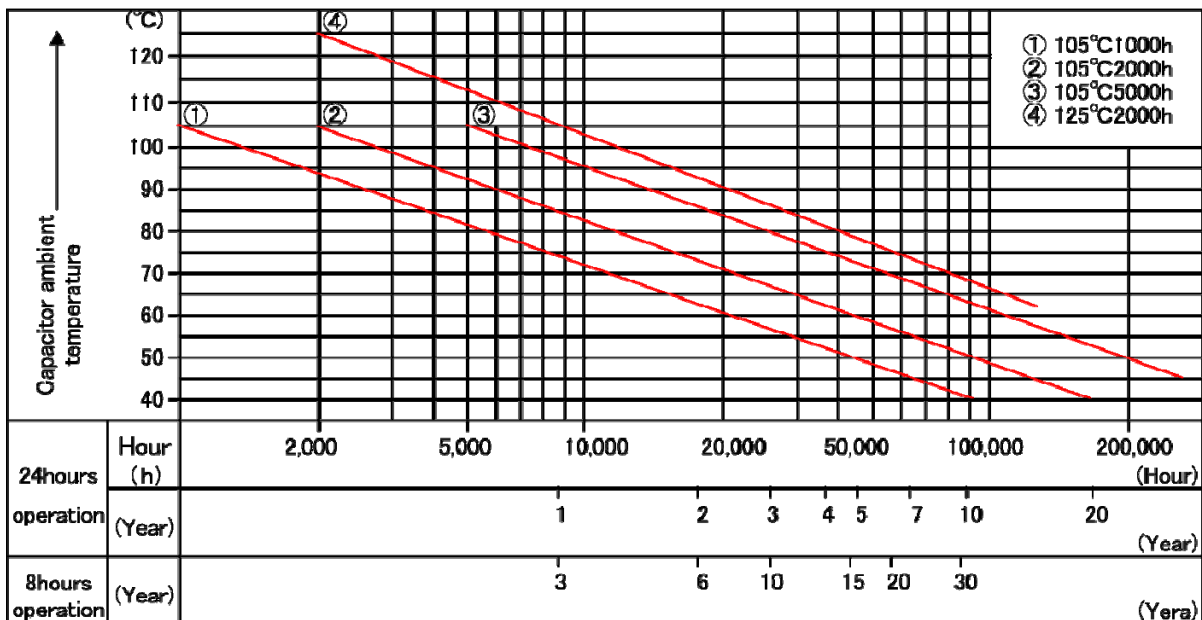

Fig.11 Derating Life Time Quick Reference Guide

•Example

1) Expected life of equipment (requested)

A : 10 years with 24h operation      B : 10 years with 8h operation a day

2) Ambient temperature of capacitor

65°C (Check · no heat generated part on reverse or around)

•Life calculation

1) For use 105°C 2000h guarantee

$$L = 2000 \times 2^{\frac{105-65}{10}}$$
$$= 2000 \times 2^4 = 32000 \quad \text{Use temperature 65°C \& expected life 32000}$$

•Capacitor selection

1) A : For 10 years with 24h operation

$$L = 24(\text{hour}) \times 365(\text{day}) \times 10(\text{year})$$
$$= 87600(\text{hour}) \quad \longleftarrow \text{Working hours for 10 years}$$

105°C 2000h product does not satisfy the expected life, so that ambient temperature should be more lower.

2) B : For 10 years with 8h operation a day

$$L = 8(\text{hour}) \times 365(\text{day}) \times 10(\text{year})$$
$$= 29200(\text{hour}) \quad \longleftarrow \text{Working hours for 10 years}$$

105°C 2000h product can be used.

## 5-2 Circuit Design ©Circuit Design Consideration

### Safety Precaution

- Applying to the equipment focused on the safety ;  
We do the best for our product quality, but short circuit (or open) may occur as failure mode such as life, etc.
- 1. Provide protection circuits and protection devices to allow safe failure modes.
- 2. Desing redundant or secondary circuits where is possible to assure continued operation in case of main circuit failure.  
Design should be considered well and safety to be assured.

The following seven points should be considered for circuit design when using surface mount type aluminum electrolytic Capacitor.

	Precaution on design	Phenomenon (Influence)
(1)Excessive voltage	Over the rated voltage is not applied ?	Capacitance reduction, $\tan \delta$ increase capacitor breakdown
(2)Reverse voltage	Reverse voltage is not applied at ON/OFF etc.? Polarity is not reversed ?	Capacitance reduction, $\tan \delta$ Increase, leakage current increase capacitor breakdown
(3)Ripple current	Ripple current is not over flown ? Heat generation by ripple current is O.K. ?	Shorter life, capacitor breakdown
(4)Charge/ Discharge	The circuit is not often repeated charge discharge ?	Shorter life, leakage current increase, capacitor breakdown
(5)Temperature characteristics	Especially, checked circuit operation at low temperature side ?	Electrical characteristics change
(6)Frequency characteristics	Checked circuit operation at high frequency range ?	Electrical characteristics change
(7)Surge (Inrush)	The circuit is not often repeated surge(Inrush) current of over hundreds A.	Shorter life short

\* Capacitor breakdown : Appearance change(Sealing part transformed)•Electrolyte will be considered.

#### (1) Excessive voltage

##### ☆ Point

**Excessive voltage over the rated should not be applied.**

**Note 1) In short time (with in 1sec), surge voltage can be applied.**

**Note 2) If there is inductance on the circuit, voltage of both side of capacitor may rise up more than expected. Especially, check reoccurred current on motor thoroughly. measure. Self heating should be within 5°C.**

If the excessive voltage over the rated is applied, oxide film self-repairing action of capacitor described in 4-1 (1) air tightness failure of the vent may cause capacitance reduction,  $\tan \delta$  increase and breakdown.

#### (2) Reverse voltage

##### ☆ Point

**Reverse voltage should not be applied.**

**Note) Use bi-polar capacitor if the reverse voltage is applied including ON/OFF of power supply, etc. (AC circuit can not be used.)**

As described in 2-1, generally, aluminum electrolytic capacitor has anode oxidized only on one side because of its construction. It is polarized construction formed oxide film.



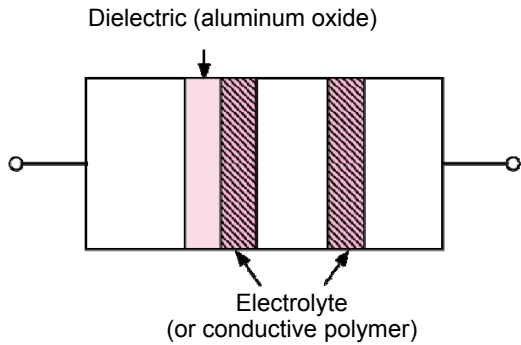

**Fig.12**

Withstand voltage is decided by the thickness of oxide film. Therefore, when applying reverse voltage, the following reaction is occurred by film self-repairing action because of no oxide film on the cathode.

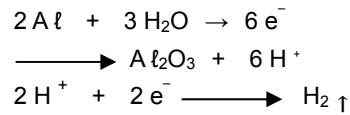

Therefore, applying long-term reversed voltage, excessive voltage and continuous pulse cycle reversed voltage may cause capacitor breakdown, such as short, open.

### (3) Ripple current

★ **Point**  
 Use a capacitor designed for higher rated ripple current than circuit ripple current.  
 Note 1) Ripple current requires frequency correction.  
 Note 2) Check the heat generation of capacitor if ripple current on the circuit is hard to measure. Self heating should be within 5°C.

#### 1) Frequency correction method for ripple current

The frequency correction factor for ripple current is an extremely significant value in that gives the ripple current stress occurring at all the frequencies which affect life the same coefficient.

As shown in Fig.13, the resistance (equivalent series resistance, ESR) which affects heat generation by ripple current tends to decrease as the frequency increases.

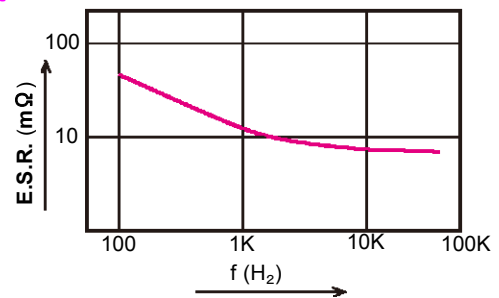

**Fig.13 ESR vs frequency (Popular characteristics change)**

Therefore, the higher the frequency is, the easier it is to flow off the ripple current.

Theoretically, where the equivalent series resistance at a certain frequency  $f$  is  $ESR(f \text{ Hz})$  and the ripple current  $i(f \text{ Hz})$ , and each at 120 Hz are  $ESR(120 \text{ Hz})$  and  $i(120 \text{ Hz})$ , and heat generated due to ripple current is the same.

$$i^2(120 \text{ Hz}) \cdot ESR(120 \text{ Hz}) = i^2(f \text{ Hz}) \cdot ESR(f \text{ Hz}) \quad (\text{Equation 2})$$

From this equation, ripple current  $i(f \text{ Hz})$  at  $f(\text{ Hz})$  is

$$i(f \text{ Hz}) = \sqrt{\frac{ESR(120 \text{ Hz})}{ESR(f \text{ Hz})}} \times i(120 \text{ Hz})$$

Where,  $\sqrt{\frac{ESR(120 \text{ Hz})}{ESR(f \text{ Hz})}}$  is the frequency correction factor.

As Panasonic, we obtain the above value for each series and group them within certain rated voltage ranges in our catalogs to simplify the listing.

#### 2) Hand measuring of circuit ripple current

Where the ripple current of circuit is hard to measure, measure the heat generation of capacitor itself. For aluminum capacitor, maximum heating specifies 5°C. If more than 5°C, life design described in 5-1 can not be made, and the life may be extremely shorten.

#### (4) Charge / Discharge

★ Point : Can not be used in the circuit which repeats charge / discharge so often.

General aluminum electrolytic capacitors have almost no current flow and no heating in normal condition. However, when charge and discharge, it generates heating due to the current flowing. Therefore, if that happens often, self heating temperature may shorten the life. For worst cases, sudden increase of leakage current and capacitor damage (electrolyte leakage, etc.) will be caused.

#### (5) Temperature characteristics

★ Point

Electrical characteristics change by temperature. See the environment of equipment, and check / select the capacitor.

Compared to solid electrolyte for ceramic capacitor, aluminum electrolytic capacitor used liquid electrolyte has more conductivity change. It makes temperature change worse, Fig.14 shows the general electrical characteristics change by temperature.

##### General

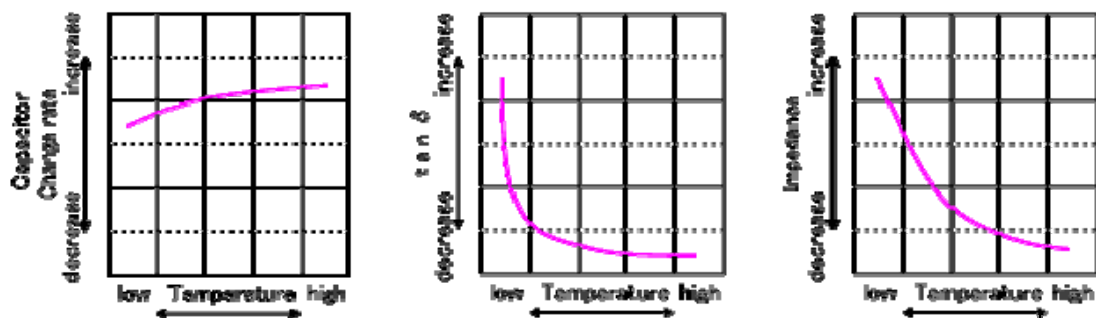

##### Hybrid

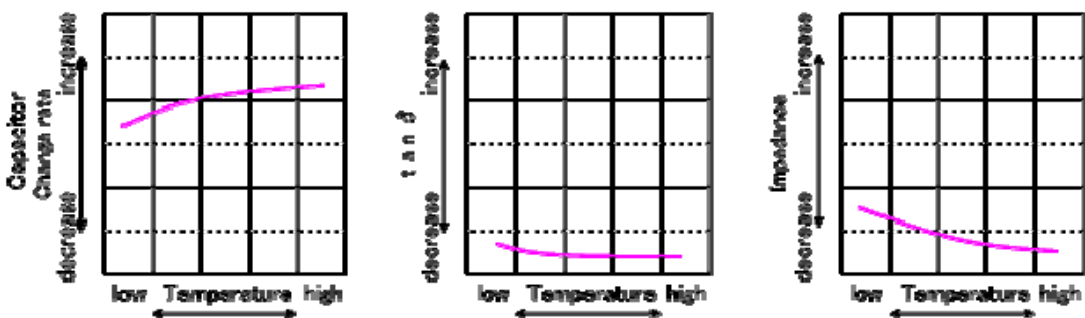

Fig.14 Electrical characteristics change by temperature

## (6) Frequency characteristics

### ☆ Point

Electrical characteristics change by frequency · consider the frequency of equipment, and check / select the capacitor.

As the same with temperature characteristics, frequency characteristics is not good because of liquid electrolyte to solid electrolyte. Fig.15 shows the general electrical characteristics change by frequency change.

### General

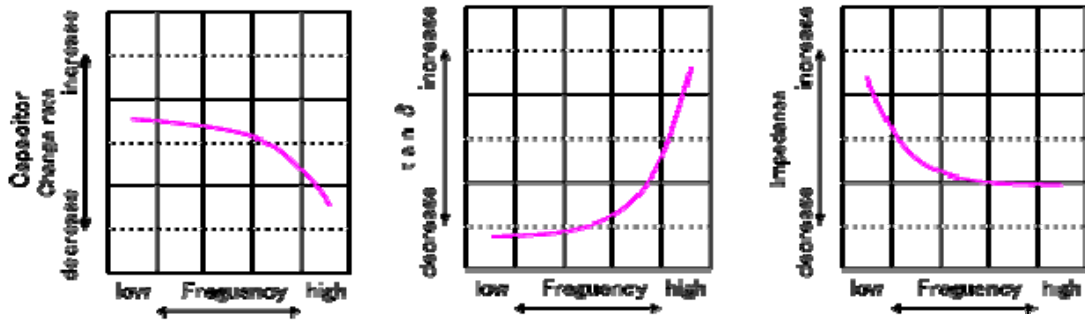

### Hybrid

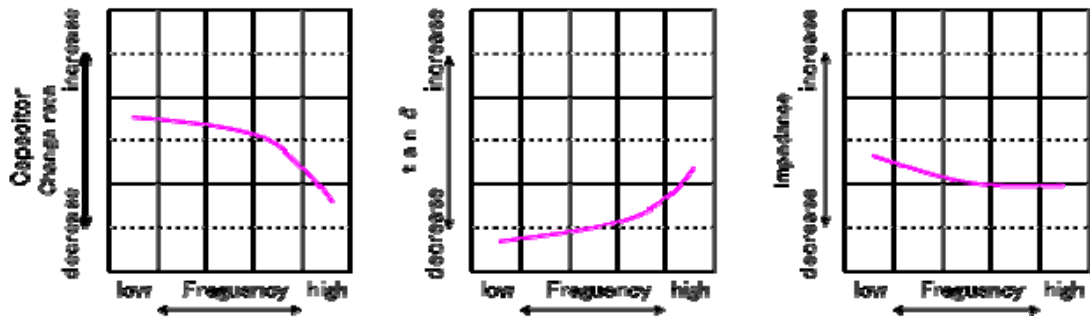

Fig.15 Electrical characteristics change by frequency

### (7) Using two or more capacitors in series or parallel

#### 1) Capacitors connected in parallel

The circuit resistance can closely approximate the series resistance of the capacitor causing an imbalance of current loads within the capacitors.

Careful design of wiring methods can minimize the possibility of excessive ripple currents applied to a capacitor.

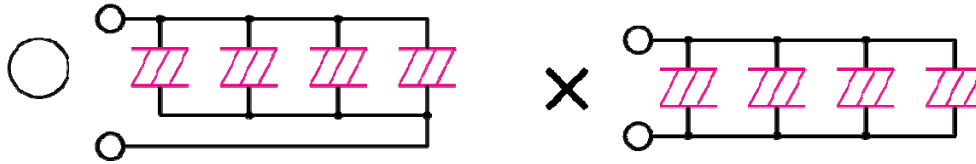
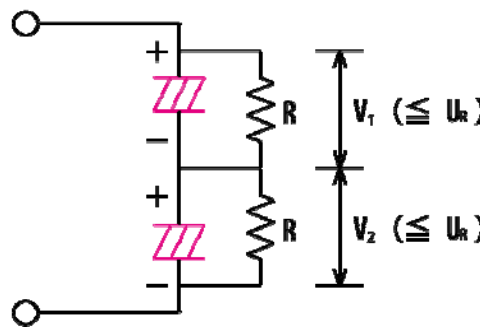

**Fig.16 Connected in parallel**

#### 2) Capacitors connected in series

Considering voltage imbalance, less than rated voltage should be applied to each capacitor ( $U_R$ ) voltage balance lose, and excessive voltage may apply.

To avoid the excessive voltage, the voltage divider shunt resistors with consideration to leakage currents be set in series with each capacitor.



**Fig.17**

### 5-3 Installation Design

Especially, following six points should be noted for installation of aluminum electrolytic capacitor.

	Precaution on design	Phenomenon (Influence)
(1) Wiring directly under capacitor	No wiring pattern under the sealing part of capacitor ?	Disconnection·Short circuit (migration)
(2)Place of heating components	No heating component placed around the capacitor ?	Greatly influence on life (capacitance reduction, tan $\delta$ increase)
(3)Land design	Ambient temperature of capacitor is clear ?	Disconnection·Short circuit, increase of leakage current)
(4)The space with adjoining part	Design the correct hole spacing to adjust terminal size of capacitor ? Avoid wiring or pattern above the pressure relief vent ?	Secondary disaster such as explosion, set damage, etc. Disconnection & ignition of wiring
(5)Consideration to the pressure relief vent	Capacitor case, the terminals and circuit pattern are isolated ? Other parts and wiring not isolated by outer sleeve ?	Disconnection, short circuit, circuit abnormality Short circuit
(6)Consideration of vibration and a shock	Is it confirmed although vibration-proof and shock nature have a difference according to a mounting state with the mounting direction or other parts about a field surface-mounted component?	Lead fracture

## (1) Consideration for wiring pattern under the capacitor

### •Point

Try to avoid wiring pattern just under the capacitor.

Note 1) If pattern wiring is required, coat with resist materials (heat curing) that have protective effects against electrolyte corrosion. Double resists are also effective. However, it might become a problem in the environments where water could condense.

Note 2) Avoid pattern wiring because it easily becomes a problem if Ag materials are used for conductor on ceramic board such as hybrid IC.

As explained in Fig.8, characteristics of aluminum electrolytic capacitor are changed by electrolyte penetration and evaporation. Electrolyte is penetrated to the bottom of capacitor with the time passing for route a in Fig.9. However, it's mostly the solvents in electrolyte and almost no possibility to become a problem due to a very little amount.

However, due to the following other factors, corrosion of pattern wiring and ion migration between pattern wiring may occur.

- 1) Moisture accelerates corrosion and migration. Especially the influence extremely arise in dew condensation, so moisture proof coating is required or pattern wiring under the capacitor is prohibited.
- 2) Electric strength (potential difference) Corrosion occurs without electric potential, but it can accelerate the corrosion as well as migration. Also, large electric strength (voltage) makes corrosion fast.
- 3) Halogen If activated agents and cleaning solvents in soldering contain halogenated substance, remnants of halogenated substance accelerate corrosion.
- 4) Conductor materials the order to easily become a problem in the materials for general use; Ag » Cu > Solder.

Therefore, if the influences of disconnection and short circuit are critical for devices, pattern wiring should be avoided.

## (2) Consideration for placing heat components around or reverse side

### •Point

Try to avoid placing heat components (power transistor, power IC, solid resistor, etc.) to the periphery or reverse side of circuit board (under the capacitor).

Note) For placing, check the temperature of capacitor (top, side, terminal, etc.)

As shown in 5-1, life design can be generally determined by ambient temperature. However, if there are heat components close-by, the temperature of capacitor may rise more than ambient temperature due to heat radiation. And, if the heat components are placed on the reverse of circuit board mounted capacitors, the heat transfers to the terminals via pattern wiring of the board, the temperature of capacitor may rise.

Either cases, be careful for misjudgment in life design at ambient temperature. It differs more than 5°C between ambient temperature and capacitor temperature, temperature, which affect the life.

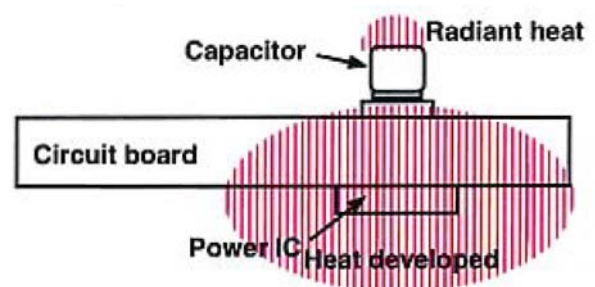

Fig.18 Influence to Heat Components



### (3) Circuit board hole spacing

When the capacitor is inserted to the print circuit board holes spacing that does not match the capacitor lead wire, the, may cause pushing stress to internal elements and damage the capacitor. Also this may lead the airtight defects and electrolyte leakage, increase of leakage current and short circuit electrically.

For lead terminal products, terminal processed products.

### (4) Consideration for the pressure relief vent

- Capacitors with case mounted pressure relief vents require sufficient clearance to allow for abnormal

Product diameter $\phi$	6.3 – 16mm	18 – 35mm	Over 40mm
Spacing	Over 2mm	Over 3mm	Over 5mm

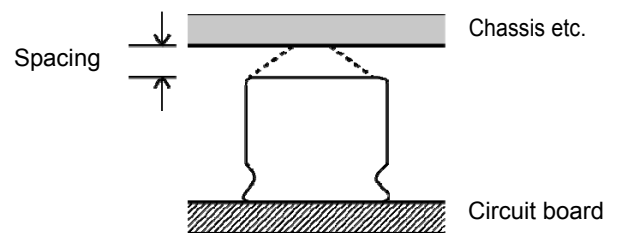

- Avoid wiring and circuit pattern above the pressure relief vent. Flammable, high temperature gas exceeding 100°C may be released which dissolve the wire insulation and ignite.

### (5) Electrical isolation of the capacitor

- Completely isolate the capacitor as follows.  
Between the cathode terminal and the case and between the anode terminal and other circuit patterns.
- The sleeve is not meant to insulate the capacitor.

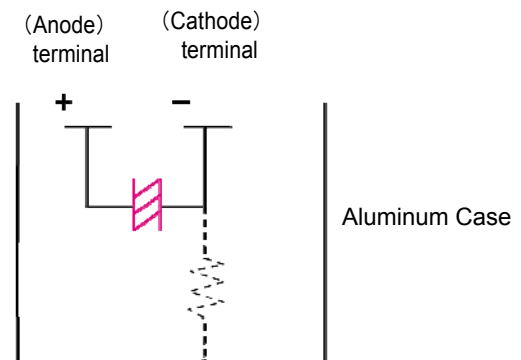

## 5-4 Operation and Storage

### (1) Installation

The followings should be noted when installing aluminum electrolytic capacitor.

Precaution on mounting	Phenomenon (influence)
(1) Verify the polarity of capacitor	Capacitor breakdown by applying the reverse voltage, such as blowout, short circuit capacitor-
(2) <ul style="list-style-type: none"> <li>•For manual soldering, if it's not specified, do not exceed 350°C for 3 seconds or less.</li> <li>•For flow soldering, if it's not specified, do not exceed 260°C for 10 seconds or less.</li> <li>•For heat curing, do not exceed 150°C for max 2 minutes.</li> </ul>	Appearance change due to the rise of internal pressure, blowout crack of vinyl sleeve, contraction.

### (2) Cleaning, Additives, Coating

	Precaution on Cleaning, Mounting adhesives, Coating	Phenomenon(influence)
1)Circuit board cleaning	•Halogenated (especially, chrdine) cleaning solvents can not be used. When cleaning, use the capacitor with guarantee.	Corrosion, disconnection
(2)Mounting adhesives, coating	•Halogenated (especially, chroline) mounting adhesives and coating materials can not be used. •Dry cleaning solution well before using mounting adhesives and coating materials. •Over 1/3 of sealing part should not be sealed.	Corrosion, disconnection

#### •Point

**Don't use halogenated(especially, chroline )cleaning solvents•adhesives•coating agents.**

If halogenated (especially, chroline) materials are used and its chroline is liberated. Internal aluminum of capacitor gets corrosion and characteristics deterioration show in the following mechanism.

### 1) Chroline liberated process

Example of cleaning solvents chlorosen (1.1.1-Trichloroethane). Even though it contains chlorine, no problem if it doesn't become free-chlorine. Also, cleaning solvents don't permeates to internal capacitor soon. It adheres to the outside of seal and is trapped, gradually, permeates to inside.

Therefore, most problems occur in the market, not soon after cleaning.

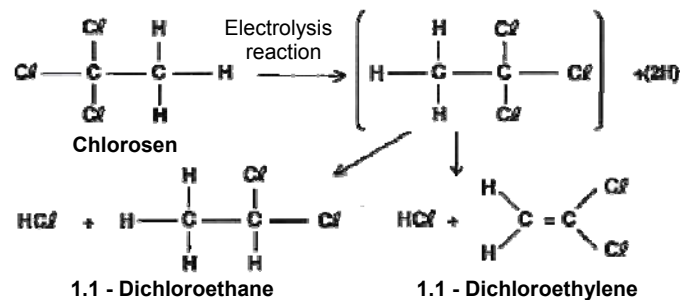
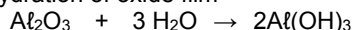

Fig.19 Decomposed reaction of cleaning solvents (Free-chlorine)

## 2) Reaction of free-chlorine and aluminum

Combined free-chlorine and hydrogen become hydrochloric acid, but it has high dissociation and mostly becomes chlorine ions. These chlorine ions react with aluminum. The order of the reactions is shown below

A) Hydration of oxide film



B) Reaction of hydrated oxide film and chlorine (Dissolution of film)

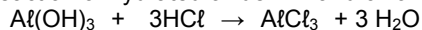

C) Reaction of aluminum and hydrochloric acid (Dissolution of aluminum)

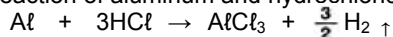

D) Precipitation of aluminum hydroxide

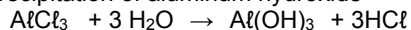

A) to D) Reaction complied A) through D)

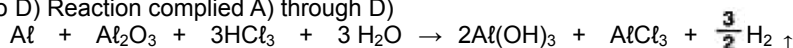

Therefore, the compounds produced by the reactions are aluminum hydroxide, aluminum hydroxide and hydrochloric acid in reaction D), the hydrochloric acid is not consumed and acts as a catalyst.

Table-3 and 4 show the propriety of cleaning solvents.

Do not use ozone destructive substance as a cleaning solvents in order to protect the global environ.

### (1) Cleaning solvents

Table-5 Solvents that can't be used

Composition	Boiling point(°C)	Common name (example)
1.1.1-Trichloroethane	74.1	Chlorosen
Trichloroethane	87.2	Trichlene
Tetrachloroethylene	121.1	Perchloroethylene

Table-6 The propriety of replace cleaning solvents

Kind of solvents	Solvents name	Manufacture	Judgment mark	Remark		
Water base	Water	Pure water	◎	No problem		
	Allaline saponifying agent	Aqua cleaner 210SEP	Sanei Kagaku	○	No problem Readout might erased Aviod using blush	
		Surface active agent	Pine Alpha ST-100S	Aralawa Kasei Kogyo		○
			Clean-thru 750H	Kao corp		○
			Clean-thru 750L			○
		Clean-thru 710M		○		
		Sun-elec B-12	Sanko Kasei	○		
DK be-clean CW-5790	Dai-Ichi Kogyo Seiyaku i KogyoSSeiyaku	○				
Solvent base	Petroleum based hydrocarbon	Cold-cleaner P3-375	Henckel Hokusui	△	Large swelling on sealing rubber Rinse and dry right After washing	
		Techno-cleaner 219	Seiwa Sangyo	△		
		Axarel 32	Mitsui DFC	△		
	Alcohol base	Isopropyle alcohol		◎	No problem	
	Silicon base	Techno-careFRW-17	Toshiba Corp.	△	No problem if you use These combination	
		Techno-careFRW-1				
		(Techno-careFRV-100)				
	Halogenated hydrocarbon	Asashi-clean AK-225AES	Ashahi Glass	△	CF base solution Not recommended, be harmful to the environment	
HCFC141b-MS		Daikin Kogyo	△			
Telpen base	Telpen-cleaner EC-7R	Nippon Alpha Metals	△	Swelling sealing rubber May swell, poor ejecting		

(Reference of  
judging mark)

Mark	Contents
◎	Cleaning is possible
○	Cleaning is possible(but the indication of part number may becomes unclear)
△	Cleaning is possible(Use caution. For recommendation,◎and ○are better)

## (2) Influence of Coating Materials

When using coating materials for insulation, waterproofing, dustproofing, rustproofing, etc., the material selected and how it is used may cause internal corrosion (chlorine reaction with aluminum) while the capacitor is being used, so be sure to observe the following.

### ○ Corrosion Reaction

Corrosion occurs when a halogen solvent infiltrates inside the capacitor through the rubber seal and it releases chlorine which reacts with the aluminum inside the capacitor.

### ○ Criteria for Selecting a Coating Material

It is necessary to select a coating material that contains no chlorine.

The composition of a coating can be mainly divided up into the main ingredient (urethane resin, acrylic resin or other polymer), solvent and various additives (flameproofing agent, etc.).

The solvent dries and also diffuses (infiltrates) into the rubber seal, and therefore coating materials containing chloride (halogenated) hydrocarbon solvents should not be used.

As with the solvent, additives can also infiltrate inside the capacitor through the rubber seal. However, their composition is often not known, so special care should be taken.

Also, if the coating material containing organic solvents, such as xylene and toluene, are used. By sealing rubber and welling, you must be careful because you may want to influence the properties by entering the internal capacitor

### ○ Others

- The solvent, additives, etc., are sometimes changed without notice, so use caution.
- Avoid coating a substrate after cleaning it with a halogenated hydrocarbon solvent (the coating will prevent remaining solvent from diffusing, which may cause corrosion).

## (3) Influence of Adhesives for Anchoring

When adhesives for anchoring are used to improve resistance to vibration, the adhesive selected and how it is used may cause internal corrosion (chlorine reaction with aluminum) while the capacitor is being used, so be sure to observe the following.

### ○ Criteria for Selecting an Adhesive

An adhesive must be selected that does not contain chlorine. The composition of an adhesive can be mainly divided up into the main ingredient (rubber, resin or other polymer) and the solvent.

The adhesive dries and also diffuses (infiltrates) into the rubber seal, and therefore adhesives containing chloride (halogenated) hydrocarbon solvents should not be used.

Also, if the adhesive material containing organic solvents, such as xylene and toluene, are used. By sealing rubber and welling, you must be careful because you may want to influence the properties by entering the internal capacitor

### ○ Others

- Some solvents are often changed, so use caution.
- Avoid using an adhesive on a substrate after cleaning it with a halogenated hydrocarbon solvent.  
(The adhesive will prevent remaining solvent from diffusing, which may cause corrosion)
- The above adhesives were found to have no effect on electrolytic capacitors. Therefore, when using any of them. Make sure they present no problems (corrosion of copper foil on printed circuit board, effect other parts, current leakage due to moisture absorption by the adhesive, etc.) on the actual substrate to be used.

When applying adhesives and coating after cleaning, a thorough drying soon after cleaning is required to remove residual cleaning solvents which may be trapped between the capacitor sealing part and the print circuit board. For the surface of adhesives and coating, over 1/3 of sealing part should not be sealed.

## 5-5 Operation and Storage

### (1) Operation and storage environment

Capacitor should not be used and stored in the following environment. It may cause the failures, such as corrosion, disconnection and shot.

- Exceeded minimum & maximum temperatures.
- Direct contact with water, salt water, or oil.
- High humidity conditions where water could condense on the capacitor.
- Exposure to toxic gases (such as hydrogen sulfide, sulfuric acid nitric acid chlorine, or ammonia).
- Exposure to ozone, radiation, or ultraviolet rays.
- Vibration and shock conditions exceeding specified requirements in catalogs or specifications .

Room temperature and humidity, with no direct sunlight should be kept.

### (2) Long term storage

Leakage current of a capacitor increases with long storage times. This is due to the deterioration of formed film at no load condition. Applying voltage decreases leakage current, but film repairing current flows a lot first, and this current surge could cause the circuit to fail.

Therefore, aging is required to repair the film in advance after long term storage.



## 6. Major Applications

### 6-1 Power Supply Circuits

Stable DC power supplies are divided into intermittent control types (switching regulator) and continuous control types (Dropper).

Recent trends have shown an overwhelming growth in switching regulators, and so we talk mainly about switching regulators below.

The capacitors used in switching regulators are selected depending on the circuit.

A forward switching regulator is shown as an example in Fig.20. Another type is a flyback regulator.

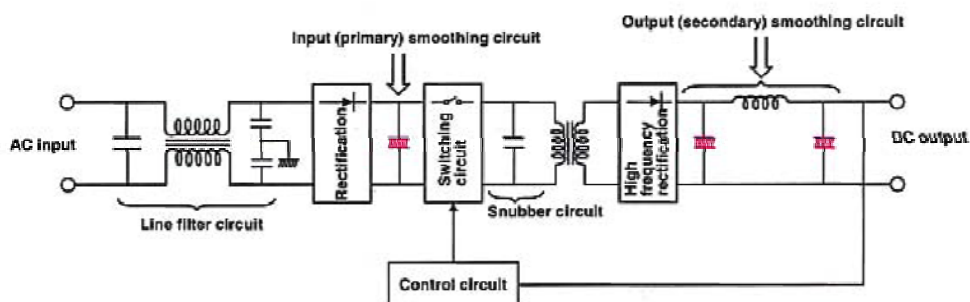

Fig.20 Example of capacitor use

### Examples of capacitor use

1. Line filter circuits: ceramic capacitors, film capacitors
2. Input smoothing circuits: aluminum electrolytic capacitors, (laminated ceramic capacitors)
3. Snubber circuits: ceramic capacitors
4. Output smoothing circuits: aluminum electrolytic capacitors, laminated ceramic capacitors, film capacitors, aluminum solid electrolytic capacitors, tantalum electrolytic capacitors
5. Control circuits: ceramic capacitors, film capacitors, tantalum electrolytic capacitors, aluminum electrolytic capacitors

### (1) Aluminum Electrolytic Capacitors for Input (Primary) Smoothing Circuits

The Aluminum electrolytic capacitors for input smoothing circuits used on commercial voltages (100 VAC, 200 VAC) and commercial frequencies (60 Hz, 50 Hz) must have a high withstand voltage and a ripple current resistance complying with twice the commercial frequency (normally full-wave current).

These capacitors have large volumes (ground contact areas) compared to other components they are assembled with, and so the demand for more compact capacitors, as well as power supplies, is strong. Another problem is the need for longer aluminum electrolytic capacitor lives, but products guaranteed for 5000 hours at 105°C have recently been developed, thus realizing freedom from maintenance for 10 years.

## (2) Aluminum Electrolytic Capacitors for Output Smoothing Circuits

The rated voltage of aluminum electrolytic capacitors used for smoothing at switching frequencies (20k to 500kHz) is determined by the output voltage, and they must have low impedance (low ESR) at switching frequencies.

Therefore aluminum electrolytic capacitors for output smoothing are designed to have low impedance at 20k to 500kHz, and the recent development of a low resistance electrolyte using new materials has resulted in products with 1/3 to 1/4 the impedance of conventional products with the same volume.

These low impedance products also have an extremely stable life.

## 6-2 Inverters

With the advancement of power devices for high electric power, semiconductor devices for controlling power supplies with capacitors from 1W to 10kW have come into practical application.

With the application of these devices, the use of electronic devices incorporating inverter circuits has rapidly increased for everything from communications, data processing and industrial use to home appliances, the most common of which is the inverter air conditioner.

The smoothing circuits of the input sections of these inverter circuits also use aluminum electrolytic capacitors.

The capacitors used in conventional series power supplies have to have a high ripple current resistance and a long life. Here we describe an example of an inverter application and the necessity of using an aluminum electrolytic capacitor in the inverter circuit and in smoothing.

### ○ General Use Inverter

Electric motors are widely used in all types of machine equipment, building ventilator fans, and factory manufacturing equipment, and the use of general use inverters for the rotational control of these motors is increasing rapidly because they permit variable speed control and improve total efficiency.

The input section of these general-use inverters smooths a 200 VAC, three-phase current employs a power

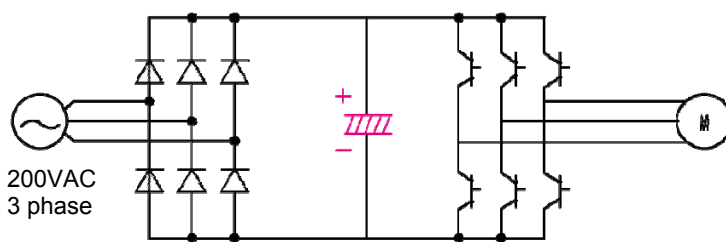

transistor to make an alternating current for driving the motor.

The principal type of circuit used is shown in this circuit. The electrolytic capacitor used in the smoothing section must normally be rated for 350–450V and have excellent ripple current resistance.

These days, by the flow of equipment to be electrification of automotive, it has been expanded, also are increasing cases of using low electrolytic capacitor voltage.

One point to be careful of when selecting a capacitor is the rated voltage since the voltages at both.

○ **Inverter Air Conditioners**

Since inverter air conditioners for home use came on the market in 1983 because of their efficiency and low power consumption, their production volume has skyrocketed..

Aluminum electrolytic capacitors are also used for input smoothing in these products, and depending on the AC power input, they can generally be classified by the following circuit types.

Input	Typical circuit	Electrolytic capacitor					
		C <sub>1</sub> , C <sub>2</sub>			C <sub>3</sub>		
		Rated voltage	Rated capacitance	Ripple current	Rated voltage	Rated capacitance	Ripple current
1 phase 100V		250V	330μF to 680μF	3A to 8A at 60Hz	330V	1300μF to 2200μF	3A to 6A at 120Hz
1 phase 200V		350V	70μF to 220μF	3A to 6A at 60Hz	350V	1300μF to 2200μF	3A to 6A at 120Hz
3 phase 200V					350V	470μF to 1000μF	2.1A to 4.5A at 120Hz

The capacitors C<sub>1</sub> and C<sub>2</sub> in particular, in the initial stage of single phase 100 VAC and 200 VAC circuits must have a low capacitance and an extremely high ripple current resistance in order to raise the power factor, and compared to capacitors for general power supply circuits, they must have high heat resistance and low loss.

To meet these needs, we are developing and manufacturing low loss anode foils and high conductivity.

○ **Others**

The use of devices employing inverter circuits is also increasing in uninterrupt power supplies, inverter power supplies for train air conditioners and other purely industrial applications.

To obtain large capacitance, multiple aluminum electrolytic capacitors are often connected in series and parallel, thus increasing the importance of capacitance balance and leakage current balance.

### 6-3. ECU for Automotive

The electronization of in-vehicle control is accelerating these days.

ECU (electrical control unit) which carries out in-vehicle control is asked for high reliance, a miniaturization, and high quality, and many aluminum electrolytic capacitors are used for it.

A typical application example is shown below.

#### (1) Power train ECU

(Engine, HV-Inverter etc.)

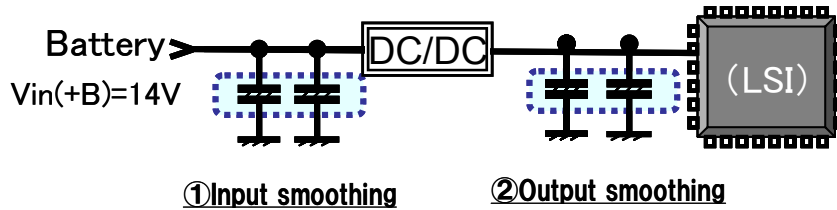

#### (2) Motor control ECU

(Power steering, a blower / radiator fan motor, an electric pump etc.)

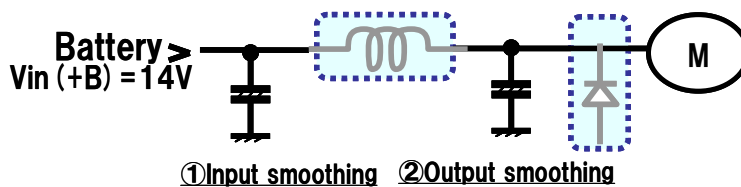

#### (3) LED Lamp

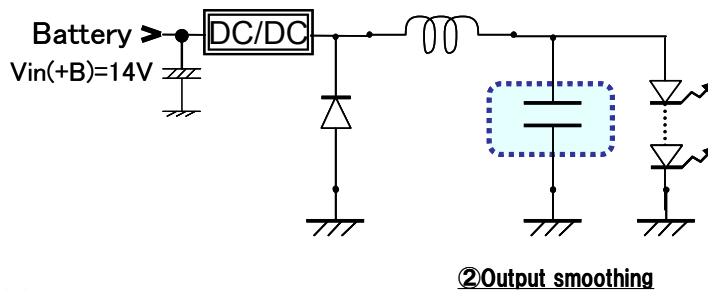

#### (4) Airbag

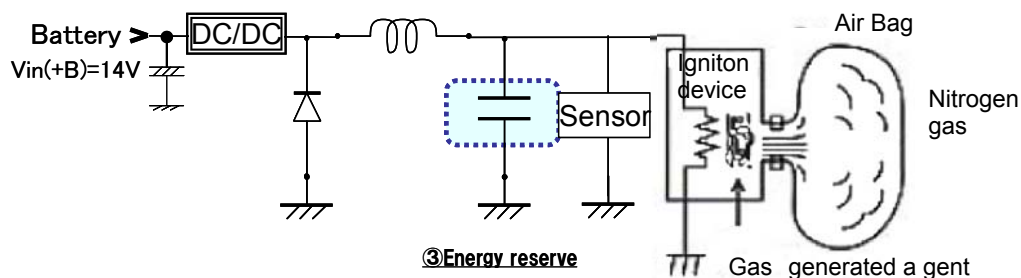

In automotive application, there are mainly an object for smoothing of input and output of the power supply of ECU and an object for energy reserve.

The rated voltage of 25V to 50V is mainly used.

Not only current aluminum capacitor, aluminum capacitor with conductive polymer and electrolyte is increasing due to improve quality, performance, with standing-voltage. It contributes to the small size of ECU, and a weight saving these days.

**MEMO**

**MEMO**





**Technical Data of Conductive Polymer Hybrid  
Aluminum Electrolytic Capacitors**

**The first edition : October 1st 1994**

**The revised edition : March 1st 2016**

**Yamaguchi Plant, Device Solutions Business Division**

**Issued by Automotive & Industrial Systems Company Panasonic Co., Ltd.**

**Tel : +81-83-922-8121**

All rights reserved. No part of this publication may be reproduced or utilized in any form or by any means, electronic or mechanical, including photocopying and microfilm, without permission in writing from the publisher.